



User's Guide

Laser Controller Modules LDC-3916370 Series



ILX Lightwave Corporation · P. O. Box 6310 · Bozeman, MT, U.S.A. 59771 · U.S. & Canada: **1-800-459-9459** · International Inquiries: 406-586-1244 · Fax 406-586-9405
E-mail: support@ilxlightwave.com

www.ilxlightwave.com

SAFETY AND WARRANTY INFORMATION



The Safety and Warranty Information section provides details about cautionary symbols used in the manual, safety markings used on the instrument, and information about the Warranty including Customer Service contact information.

Safety Information and the Manual

Throughout this manual, you will see the words *Caution* and *Warning* indicating potentially dangerous or hazardous situations which, if not avoided, could result in death, serious or minor injury, or damage to the product. Specifically:

CAUTION

Caution indicates a potentially hazardous situation which can result in minor or moderate injury or damage to the product or equipment.

WARNING

Warning indicates a potentially dangerous situation which can result in serious injury or death.

WARNING

Visible and/or invisible laser radiation. Avoid direct exposure to the beam.

General Safety Considerations

If any of the following conditions exist, or are even suspected, do not use the instrument until safe operation can be verified by trained service personnel:

- Visible damage
- Severe transport stress
- Prolonged storage under adverse conditions
- Failure to perform intended measurements or functions

If necessary, return the instrument to ILX Lightwave, or authorized local ILX Lightwave distributor, for service or repair to ensure that safety features are maintained.

All instruments returned to ILX Lightwave are required to have a Return Authorization Number assigned by an official representative of ILX Lightwave Corporation.

SAFETY SYMBOLS









This section describes the safety symbols and classifications.

Technical specifications including electrical ratings and weight are included within the manual. See the Table of Contents to locate the specifications and other product information. The following classifications are standard across all ILX Lightwave products:

- Indoor use only
- Ordinary Protection: This product is NOT protected against the harmful ingress of moisture.
- Class I Equipment (grounded type)
- Mains supply voltage fluctuations are not to exceed $\pm 10\%$ of the nominal supply voltage.
- Pollution Degree II
- Installation (overvoltage) Category II for transient overvoltages
- Maximum Relative Humidity: $< 80\%$ RH, non-condensing
- Operating temperature range of $0\text{ }^{\circ}\text{C}$ to $40\text{ }^{\circ}\text{C}$
- Storage and transportation temperature of $-40\text{ }^{\circ}\text{C}$ to $70\text{ }^{\circ}\text{C}$
- Maximum altitude: 3000 m (9843 ft)
- This equipment is suitable for continuous operation.

Safety Marking Symbols

This section provides a description of the safety marking symbols that appear on the instrument. These symbols provide information about potentially dangerous situations which can result in death, injury, or damage to the instrument and other components.

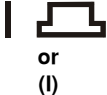
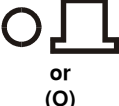
 <p>Caution, refer to manual</p>	 <p>Earth ground Terminal</p>	 <p>Alternating current</p>	 <p>Visible and/or invisible laser radiation</p>
 <p>Caution, risk of electric shock</p>	 <p>Protective Conductor Terminal</p>	 <p>Caution, hot surface</p>	 <p>Frame or chassis Terminal</p>
 <p>On: In position of a bistable push control. The slash (I) only denotes that mains are on.</p>		 <p>Off: Out position of a bistable push control. The circle (O) only denotes that mains are off.</p>	

WARRANTY

ILX LIGHTWAVE CORPORATION warrants this instrument to be free from defects in material and workmanship for a period of one year from date of shipment. During the warranty period, ILX will repair or replace the unit, at our option, without charge.

Limitations

This warranty does not apply to fuses, lamps, defects caused by abuse, modifications, or to use of the product for which it was not intended.

This warranty is in lieu of all other warranties, expressed or implied, including any implied warranty of merchantability or fitness for any particular purpose. ILX Lightwave Corporation shall not be liable for any incidental, special, or consequential damages.

If a problem occurs, please contact ILX Lightwave Corporation with the instrument's serial number, and thoroughly describe the nature of the problem.

Returning an Instrument

If an instrument is to be shipped to ILX Lightwave for repair or service, be sure to:

- 1 Obtain a Return Authorization number (RA) from ILX Customer Service.
- 2 Attach a tag to the instrument identifying the owner and indicating the required service or repair. Include the instrument serial number from the rear panel of the instrument.
- 3 Attach the anti-static protective caps that were shipped with the instrument and place the instrument in a protective anti-static bag.
- 4 Place the instrument in the original packing container with at least 3 inches (7.5 cm) of compressible packaging material. **Shipping damage is not covered by this warranty.**
- 5 Secure the packing box with fiber reinforced strapping tape or metal bands.
- 6 Send the instrument, transportation pre-paid, to ILX Lightwave. Clearly write the return authorization number on the outside of the box and on the shipping paperwork. ILX Lightwave recommends you insure the shipment.

If the original shipping container is not available, place your instrument in a container with at least 3 inches (7.5 cm) of compressible packaging material on all sides.

Repairs are made and the instrument returned transportation pre-paid. Repairs are warranted for the remainder of the original warranty or for 90 days, whichever is greater.

Claims for Shipping Damage

When you receive the instrument, inspect it immediately for any damage or shortages on the packing list. If the instrument is damaged, file a claim with the carrier. The factory will supply you with a quotation for estimated costs of repair. You must negotiate and settle with the carrier for the amount of damage.

Comments, Suggestions, and Problems

To ensure that you get the most out of your ILX Lightwave product, we ask that you direct any product operation or service related questions or comments to ILX Lightwave Customer Support. You may contact us in whatever way is most convenient:

Phone (800) 459-9459 or (406) 586-1244

Fax (406) 586-9405

Email support@ilxlightwave.com

Or mail to:

ILX Lightwave Corporation
P. O. Box 6310
Bozeman, Montana, U.S.A 59771
www.ilxlightwave.com

When you contact us, please have the following information:

Model Number: _____

Serial Number: _____

End-user Name: _____

Company: _____

Phone: _____

Fax: _____

Description or sketch of what
is connected to the ILX
Lightwave instrument:

Description of the problem:

If ILX Lightwave determines that a return to the factory is necessary, you are issued a Return Authorization (RA) number. Please mark this number on the outside of the shipping box.

You or your shipping service are responsible for any shipping damage when returning the instrument to ILX Lightwave; ILX recommends you insure the shipment. If the original shipping container is not available, place your instrument in a container with at least 3 inches (7.5cm) of compressible packaging material on all sides.

We look forward to serving you even better in the future!

Table of Contents

Module Instruction Manual

Chapter 1 Introduction to the LDC-3916370 Series Controller Modules

Introduction	1
Safety Symbols and Terms	1
Product Overview	2
Initial Inspection	2
Installing your LDC-3916370 Series Laser Diode Controller Module	2
LDC-3916370 Series Controller Module Specifications	4

Chapter 2 How to Operate Your LDC-3916370 Series Controller Module

Introduction	1
Connecting to the Laser Controller	2
Connecting to the TEC Controller	5
Operating the Laser Current Source from the Front Panel	6
Operating a Laser in Constant Current (I) Mode	6
Operating a Laser in Constant Power (P) Mode	9
Conditions which will Automatically Shut Off the Laser Output	12
Operating the TEC Controller from the Front Panel	14
Operating the Controller in Constant Temperature (T) Mode	14
TEC Error Indicators	19

Chapter 3 Operating in Remote Control

Introduction	1
Remote Configuration	1
LDC-3916370 Series Laser Diode Controller Command Set	1
Status Reporting	4

Chapter 4 Command Reference

Introduction	1
LDC-3916370 Series Device-Dependent Commands	4
LDC-3916370 Series Device-Command Reference	4
Commands listed in Alphabetical Order	5 - 68

Chapter 5 Calibration and Troubleshooting Guide

Introduction	1
Calibration Overview	1
Local Calibration of the Temperature Controller	3
Local Calibration of the Laser Current Source	5
Remote Calibration of the 3916370 Controller	8
Troubleshooting Guide	17

CHAPTER 1	1
INTRODUCTION TO THE LDC-3916370 SERIES CONTROLLER MODULES	1
INTRODUCTION	1
SAFETY SYMBOLS AND TERMS	1
PRODUCT OVERVIEW	2
INITIAL INSPECTION	2
INSTALLING YOUR LDC-3916370 SERIES LASER DIODE CONTROLLER MODULE	2
Installation into LDC-3916 Laser Diode Controller Mainframe	2
General Shipping Instructions	3
LDC-3916370 SERIES CONTROLLER MODULE SPECIFICATIONS	4
Laser Current Source Specifications	4
Temperature Controller Specifications	5

CHAPTER 1

INTRODUCTION TO THE LDC-3916370 SERIES CONTROLLER MODULES

INTRODUCTION

This chapter is an introduction to the LDC-3916370 Series Laser Diode Controller Modules for the LDC-3916 LD Controller Mainframe containing unpacking information, instructions on how to install and apply power, and safety considerations and instructions. It also contains some maintenance information and specifications. It covers model numbers LDC-3916372 500 mA/9W Controller Module, LDC-3916374 1A/9W Controller Module, and LDC-3916376 1.5A/9W Controller Module.

WARNING

If any of the following symptoms exist, or are even suspected, remove the LDC-3916370 Series Controller Module from service. Do not use the module until safe operation can be verified by trained service personnel.

1. *Visible damage*
2. *Severe transport stress*
3. *Prolonged storage under adverse conditions*
4. *Failure to perform intended measurements or functions*

If necessary, return the module to ILX Lightwave for service and repair to ensure that safety features are maintained.

SAFETY SYMBOLS AND TERMS

The following safety terms are used in this manual:

- The **WARNING** heading explains dangers that could result in personal injury or death.
- The **CAUTION** heading explains hazards that could damage your instrument.
- The **NOTES** heading gives information to the user that may be beneficial in the use of the instrument and to the devices being tested.

The following symbols are used in this manual and on the instrument:



Earth Ground and/or Protective Conductor Terminal



Caution: Refer to accompanying documents



Caution: Risk of Electrical Shock



Instrument Power Off



Instrument Power On

PRODUCT OVERVIEW

The LDC-3916370 Series Laser Diode Controller Modules are a combination current source/temperature controller. The current source provides high stability output of either 500 mA, 1 Amp, or 1.5 Amp with fully redundant current limits and multiple laser protection features such as contact bounce detection, compliance voltage limit adjust and 4-wire voltage measurement for precise laser diode forward voltage measurement. The built-in bi-polar temperature controller can work with thermistor type temperature sensors and most TEC modules to deliver precise laser temperature control over a wide range of temperatures. Other features of the TEC control circuit include TEC voltage measurement, digital selection of thermistor current range, and control loop gain adjustment from 1 to 127.

INITIAL INSPECTION

When you receive your Controller module, inspect it for any shipping damage. A shipping kit should be included which contains 9-pin and 15-pin D-connectors and hoods plus this Instruction Manual.

INSTALLING YOUR LDC-3916370 SERIES LASER DIODE CONTROLLER MODULE

Installation into LDC-3916 Laser Diode Controller Mainframe

If you are receiving this new module for installation into a previously purchased LDC-3916 mainframe, follow the instructions below. If your mainframe system was configured at the factory with your desired modules, use this section for reference when moving modules.

Turn off the mainframe power switch before inserting or removing any modules. Damage from "hot swapping" the modules is not covered under the warranty.

CAUTION

Static discharge can damage your new Laser Diode Controller Module. Be certain you use proper grounding procedures before you unpack and install your controller module(s) into the LDC-3916 Mainframe.

Inspect the module for any visible shipping damage that may have occurred before inserting the module into the mainframe. Pay special attention to the copper shielding material on the back edge of the module.

Be sure that the LDC-3916 Mainframe power is off before inserting your new laser diode controller module. Damage from "hot swapping" is not included under the warranty.

Unwrap the module from the anti-static bag it was packaged in.

Insert the module into the desired slot from the rear of the LDC-3916 Mainframe. Each module is supported by two plastic card guides inside of the mainframe. Insert the module, 40 pin connector first, by lining up the edges of the module frame with the appropriate card guides (one on top and one on the bottom). Carefully slide the module into the mainframe slot until the connector is seated. Push firmly to fully seat the module until the rear panel of the module is flush with the mainframe. Fasten the module to the mainframe with two screws located at the top and bottom of the module rear panel.

General Shipping Instructions

If you need to ship your LDC-391637X Laser Diode Controller Module back to the factory for repair, be sure that the module is packaged in an anti-static bag and an enclosure with cushioning material to prevent damage to the module during shipment (use the original shipping containers and accessories if possible). Re-install the ESD protective caps on the rear panel over the connectors (9-pin and 15-pin D). Shipping damage is not covered under warranty.

Attach a tag to the module identifying the owner and indicating the service or repair needed. Include the model number, serial number, and return authorization number. We suggest that you insure the shipment. See your LDC-3916 Mainframe manual for instructions on where to ship the module.

LDC-3916370 SERIES CONTROLLER MODULE SPECIFICATIONS

Laser Current Source Specifications

MODEL NUMBER:	3916372 500mA/9W	3916374 1A/9W	3916376 1.5A/9W
----------------------	-------------------------	----------------------	------------------------

LASER CURRENT DRIVE OUTPUT¹

Output Current Range:	0 to 500 mA	0 to 1000 mA	0 to 1500 mA
Set-Point Resolution:	10 μ A	20 μ A	40 μ A
Set-Point Accuracy:	\pm 0.1% of full scale	\pm 0.1% of full scale	\pm 0.1% of full scale
Compliance Voltage:	6 V (adjustable voltage limit)	6 V (adjustable voltage limit)	4.75 V (adjustable voltage limit)
Temperature Coefficient:	\leq 50 ppm/ $^{\circ}$ C	\leq 50 ppm/ $^{\circ}$ C	\leq 50 ppm/ $^{\circ}$ C
Short-Term Stability (1 hr.): ²	\leq 20 ppm	\leq 20 ppm	\leq 20 ppm
Long-Term Stability (24 hr.): ³	\leq 50 ppm	\leq 50 ppm	\leq 50 ppm
Noise and Ripple: ⁴			
High Bandwidth Mode:	< 10 μ A mss	< 10 μ A mss	< 12 μ A mss
Low Bandwidth Mode:	< 5.0 μ A mss	< 5.0 μ A mss	< 8.0 μ A mss
Transients:			
Operational: ⁵	< 3 mA	< 3 mA	< 3 mA
1kV EFT / Surge: ⁶	< 4 mA / < 8 mA	< 5 mA / < 10 mA	< 5 mA / < 10 mA

LASER DRIVE LIMIT SETTINGS

Current Limit Range:	0 to 500 mA	0 to 1000 mA	0 to 1500 mA
Current Limit Resolution:	0.2 mA	0.4 mA	0.6 mA
Current Limit Accuracy:	\pm 0.7 mA	\pm 1.4 mA	\pm 4.5 mA
Voltage Limit Range:	0 to 7.5 V	0 to 7.5 V	0 to 7.5 V
Voltage Limit Resolution:	0.1 V	0.1 V	0.1 V
Voltage Limit Accuracy:	\pm 0.2 V	\pm 0.2 V	\pm 0.2 V

PHOTODIODE FEEDBACK

Type:	Differential 10 Ω Input, Selectable Zero or 5V Reverse Bias	Differential 10 Ω Input, Selectable Zero or 5V Reverse Bias	Differential 10 Ω Input, Selectable Zero or 5V Reverse Bias
PD Current Range:	0 to 5,000 μ A	0 to 5,000 μ A	0 to 5,000 μ A
Stability: ⁷	\pm 0.01%	\pm 0.01%	\pm 0.01%
Accuracy, setpoint (% of FS):	\pm 0.1%	\pm 0.1%	\pm 0.1%

EXTERNAL ANALOG MODULATION

Input : ⁸	0 to 10V, 50 Ω	0 to 10V, 50 Ω	0 to 7.5V, 50 Ω
Transfer Function:	50 mA / V	100 mA / V	200 mA / V
High Bandwidth Mode, Small Signal Bandwidth: ⁹	DC to 1.2 MHz	DC to 1.0 MHz	DC to 0.9 MHz
High Bandwidth Mode, Large Signal Bandwidth: ¹⁰	DC to 1.0 MHz	DC to 1.0 MHz	DC to 0.9 MHz
Low Bandwidth Mode:	DC to 30 kHz	DC to 30 kHz	DC to 30 kHz

LASER CURRENT MEASUREMENT (DISPLAY)

Output Current Range:	0 to 500.00 mA	0 to 1000.0 mA	0 to 1500.0 mA
Output Current Resolution:	0.01 mA	0.01 mA	0.01 mA
Output Current Accuracy (@25 $^{\circ}$ C):	\pm 0.05% of full scale	\pm 0.05% of full scale	\pm 0.07% of full scale
Photodiode Current Range:	0 to 5,000 μ A	0 to 5,000 μ A	0 to 5,000 μ A
PD Current Resolution:	0.1 μ A	0.1 μ A	0.1 μ A
PD Current Accuracy (@25 $^{\circ}$ C):	\pm 2 μ A	\pm 2 μ A	\pm 2 μ A
PD Responsivity Range: ¹¹	0.00 to 1000.00 μ A/mW	0.00 to 1000.00 μ A/mW	0.00 to 1000.00 μ A/mW
PD Responsivity Resolution:	0.01 μ A/mW	0.01 μ A/mW	0.01 μ A/mW
Optical Power Range:	0.00 to 500.00 mW	0.00 to 500.00 mW	0.00 to 500.00 mW
Optical Power Resolution:	100 μ W	100 μ W	100 μ W
Forward Voltage Range:	0.000 to 7.5 V	0.000 to 7.5 V	0.000 to 7.5 V
Forward Voltage Resolution:	10 mV (1 mV through GPIB)	10 mV (1 mV through GPIB)	10 mV (1 mV through GPIB)
Forward Voltage Accuracy: ¹²	\pm 7 mV (\pm 2 mV through GPIB)	\pm 7 mV (\pm 2 mV through GPIB)	\pm 7 mV (\pm 2 mV through GPIB)

CURRENT SOURCE NOTES:

1. All values relate to a one-hour warm-up period.
2. Over any 1-hour period, half-scale output.
3. Over any 24-hour period, half-scale output.
4. Measured optically, evaluating noise intensity of a laser diode into a photodetector with 150 kHz bandwidth.
5. Maximum output current transient resulting from normal operational situations (e.g., power on-off, current on-off), as well as accidental situations (e.g., power line plug removal).
6. Maximum output current transient resulting from a 1000V power-line transient spike.
7. Maximum monitor photodiode current drift over any 30 minute period. Assumes zero drift in responsivity of photodiode.
8. Modulation input is 50 Ω terminated inside the mainframe.

9. 250 mA set point, 50 mA modulation current, 1 Ω load.
10. 50% modulation at mid-scale output, 1 Ω load
11. Responsivity value is user-defined and is used to calculate the optical power.
12. Four wire voltage measurement. Voltage measurement accuracy while driving calibration load. Voltage accuracy specifications valid for values above 10mV.

Temperature Control Specifications

Temperature Control¹

3916372, 3916374, and 3916376

Temperature Control Range: ²	-99 °C to +150 °C
Thermistor Setpoint	
Resolution and Accuracy:	<u>Resolution</u> <u>Accuracy</u> ³
-20 °C to 20 °C	0.1 °C ± 0.2 °C
20 °C to 50 °C	0.2 °C ± 0.2 °C
Short Term Stability (1 hr.): ⁴	< ± 0.007 °C
Long Term Stability (24 hrs.): ⁵	< ± 0.01 °C
Output Type:	Bipolar current source
Compliance Voltage:	> 7 V DC
Short Circuit Output Current:	1.5 Amps
Maximum Output Power:	9 Watts
Current Noise and Ripple: ⁶	< 1 mA rms
Current Limit Range:	0 to 1.5 Amps
Current Limit Set Accuracy:	± 0.05 Amps
Control Algorithm:	Smart Integrator, Hybrid PI Gain adjustable from 1 to 127

TEMPERATURE SENSOR

Types:	Thermistor (2-wire NTC)
Thermistor Sensing Current: ⁷	10 μ A / 100 μ A
Useable Thermistor Range:	25 to 450,000 Ω typical
User Calibration:	Steinhart-Hart, 3 constants

TEC MEASUREMENT (DISPLAY)

Temperature	
Range: ⁸	-99.9 °C to +199.9 °C
Accuracy:	± 0.5 °C
Thermistor Resistance	
10 μ A Setting: ⁹	
Range:	0.01 to 450.00 k Ω
Accuracy:	± 0.05 k Ω
100 μ A Setting: ¹⁰	
Range:	0.001 to 45.000 k Ω
Accuracy:	± 0.005 k Ω
TEC Current	
Range:	-1.500 to +1.500 Amps
Accuracy:	± 0.04 Amps
Voltage	
Range:	-9.999 to +9.999 V
Resolution:	100 mV (1 mV through GPIB)
Accuracy: ¹¹	± 70 mV (± 20 mV through GPIB)

TEMPERATURE CONTROL NOTES

1. All values relate to a one-hour warm-up period.
2. Software limits of range. Actual range possible depends on the physical load, thermistor type, and TEC module used.
3. Accuracy figures are quoted for a typical 10 k Ω thermistor and 100 μ A current setting. Accuracy figures are relative to the calibration standard. Both resolution and accuracy are dependent upon the user-defined configuration of the instrument.
4. Over any 1-hour period, half-scale output, controlling an LDM-4412 mount @ 25 °C, with 10 k Ω thermistor, on 100 μ A setting.
5. Over any 24-hour period, half-scale output, controlling an LDM-4412 mount @ 25 °C, with 10k Ω thermistor, on 100 μ A setting.
6. Measured at 1 Amp output over a bandwidth of 10 Hz – 10 MHz.
7. Thermistor current range software selectable by front panel or GPIB.
8. Software limits of display range.
9. Using a 100 k Ω thermistor, controlling an LDM-4412 mount over -30°C to +25 °C
10. Using a 10 k Ω thermistor, controlling an LDM-4412 mount over 0 °C to +90 °C
11. Voltage measurement accuracy while driving calibration load. Accuracy is dependent upon load used.

In keeping with our commitment to continuing improvement, ILX Lightwave reserves the right to change specifications without notice or liability for such changes.

CHAPTER 2	1
HOW TO OPERATE YOUR LDC-3916370 SERIES CONTROLLER MODULE	1
INTRODUCTION	1
CONNECTING TO THE LASER CONTROLLER	2
Interlock Connections	4
Photodiode Connections	4
Grounding Considerations	4
CONNECTING TO THE TEC CONTROLLER	5
TEC Grounding Considerations	5
OPERATING THE LASER CURRENT SOURCE FROM THE FRONT PANEL	6
OPERATING A LASER IN CONSTANT CURRENT (I) MODE	6
Entering the Laser Channel Setup Menu	6
Selecting the Mode of Control	6
Setting the Current Limit	7
Setting the Constant Current Value	7
Setting the Voltage Limit	7
Enabling the Modulation Input	8
Setting Photodiode Bias Voltage	8
Turning the Laser Current Source On	8
OPERATING A LASER IN CONSTANT POWER (P) MODE	9
Calculating Photodiode Responsivity Values	9
Entering the Laser Channel Setup Menu	9
Selecting the Mode of Control	9
Setting the Current Limit	10
Setting the Voltage Limit	10
Setting the Power Limit	10
Adjusting the Constant Power Setting	11
Setting the Responsivity Value (CalPD)	11
Setting the Photodiode Bias Voltage	11
Enabling the Modulation Input	11
Constant Power Mode If CalPD is Unknown	12
Turning the Laser Current Source On	12
CONDITIONS WHICH WILL AUTOMATICALLY SHUT OFF THE LASER OUTPUT	12
Laser Error Indicators	13
OPERATING THE TEC CONTROLLER FROM THE FRONT PANEL	14
Selecting the TEC Control Setup Menu	14
OPERATING THE CONTROLLER IN CONSTANT TEMPERATURE (T) MODE	14
Selecting the TEC Control Mode	15
Setting the Temperature Limit	15
Adjusting the Temperature Set Point	15
Setting TEC Current Limit	16
Setting TEC Control Loop Gain	16
Temperature Controller Sensor Selection	17
Setting Temperature Sensor Constants	17
Conditions Which Will Automatically Shut Off the TEC Output	18
TEC ERROR INDICATORS	19

CHAPTER 2

HOW TO OPERATE YOUR LDC-3916370 SERIES CONTROLLER MODULE

INTRODUCTION

This chapter introduces you to the operation of the LDC-3916370 Series LD Controllers' Laser and TEC control functions. It offers instructions for connecting your laser to the current source and temperature controller. This chapter also contains step by step procedures that teach you how to operate your controller module in Constant Current Mode, Constant Power Mode, and to operate the temperature controller in Constant Temperature Mode. We recommend that you review the contents of this chapter at a minimum before operating your LDC-3916 Laser Diode Controller.

LDC-3916370 SERIES CONTROLLER DEFAULT CONFIGURATION

TEC CONTROLLER

TEC output off
TEC Mode = Constant Temperature (T)
Temperature Set Point (T or Tset) = 22°C
TEC current set point (ITE or Iset) = 1.0 Amp
TEC current limit (LIM:ITE or Ilim) = 1.0 Amp
Temperature limit (LIM:THI or Tlim) = 80.0°C
TEC resistance set point (R or Rset) = 10 kW
TEC Tolerance values = 0.2°C, 5 seconds
GAIN = 3
TEC SENSOR current set to 100 mA range
C1 = 1.125 (x 10⁻³)
C2 = 2.347 (x 10⁻⁴)
C3 = 0.855 (x 10⁻⁷)

LASER CONTROLLER

LASER output off
LAS current set point (LDI or Iset) = 50 mA
LAS current limit (LIM:I or Ilim) = 150 mA
LAS voltage limit (LIM:V or Vlim) = 5.0 V
LAS Mode = Constant Current, low bandwidth mode (MODE:ILBW or Ilbw)
Modulation off
Optical power set point (MDP or Pset) = 3.0 mW
Monitor responsivity (CALPD or CalPD) = 0.0 mA/mW
Optical power limit (LIM:MDP or Plim) = 500 mW
Monitor PD Bias off
LASER STEP value = 0.1mA
Monitor PD current set point (MDI or Ipdset) = 100 mA

Table 2.1 LDC-3916370 Series Controllers Default Settings

CONNECTING TO THE LASER CONTROLLER

When connecting your laser diode or any other sensitive devices to the LDC-3916370 Series Laser Diode Controller Modules, we recommend that the instrument be powered up and the **LASER** output be off. In this condition, a low impedance shunt is active across the output terminals. When disconnecting devices, it is only necessary to turn the **LASER** Output off.

It is also recommended that the connections to the LDC-3916370 Series Laser Diode Controller module output be made using twisted wire pairs with an earth-grounded shield (see Figures 2.1 A - D). We recommend using our CC-305S or shorter CC-315S Shielded Laser Cable which are unique twisted-pair cables with braided outer shield designed to provide the best possible rejection of most transient noise signals. The output terminals of the instrument are left floating relative to earth ground to suppress AC power-on/power-off transients that may occur through an earth-ground path. If the output circuit is earth-grounded at some point (such as through the laser package and mount), the user must be careful to avoid multiple earth grounds in the circuit. Multiple earth grounds may provide circuit paths that induce spurious currents in the photodiode feedback circuit and output leads.

NOTE

Experience indicates that should an inadvertent open circuit occur during laser operation (while the LASER is ON), your laser may be damaged by a momentary circuit break-and-remake before the final circuit break. Your new LDC-3916370 Series Controller Module has circuitry designed to detect open circuits and will shut the output off under most conditions. However, we recommend that cable connections to the laser be secure enough that they won't open-circuit, should they be jostled or bumped.

Use appropriately shielded cabling to reduce coupling of potentially laser damaging transients. Do not "bundle" the current source cables with other cables in your system or laboratory. See Application Note #3, "Laser Diode Protection Strategies" for more detailed discussions on connecting to your laser.

Figures 2.1 A - D show the possible configurations of connecting laser diodes and photodiodes with the LDC-3916370 Series Laser Diode Controller Modules.

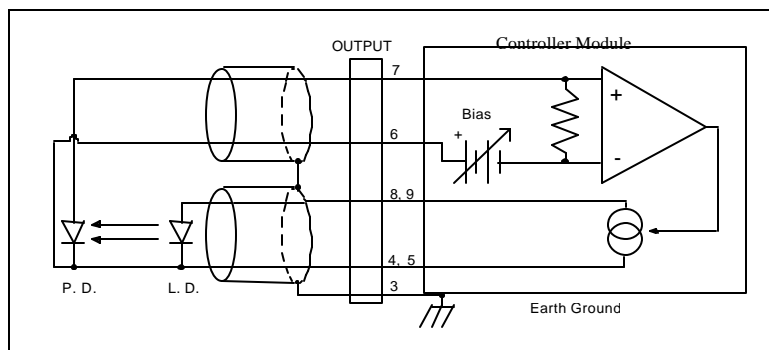

Figure 2.1 A Common Laser Cathode - Photodiode Cathode

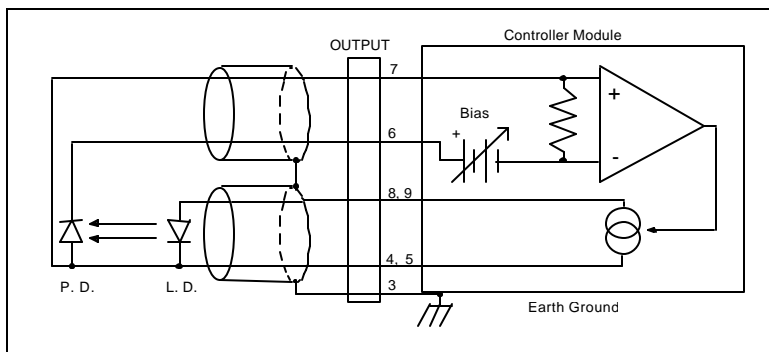

Figure 2.1 B Common Laser Cathode - Photodiode Anode

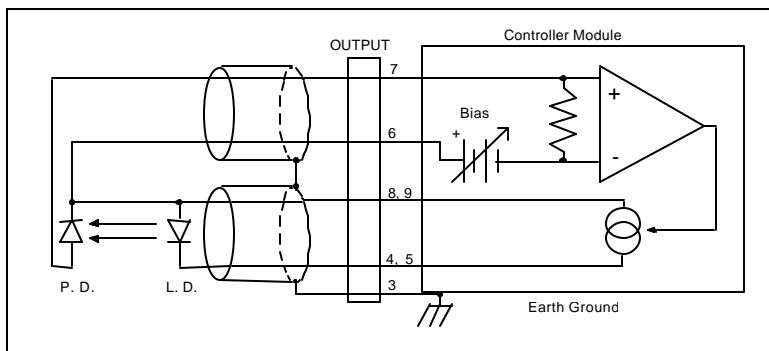

Figure 2.1 C Common Laser Anode - Photodiode Cathode

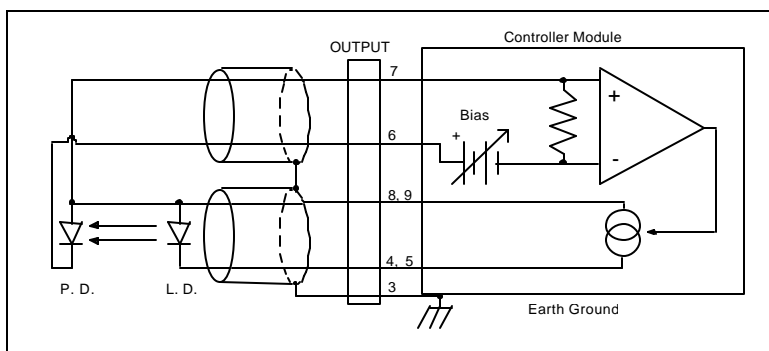

Figure 2.1 D Common Laser Anode - Photodiode Anode

The 9-pin connector on the rear panel (bottom connector) of your Controller Module is used to connect your laser diode to the controller. There are connections provided for laser cathode and anode, photodiode cathode and anode, chassis ground, interlock, and laser forward voltage. The pin-out diagram for this connector is shown in Figure 2.2.

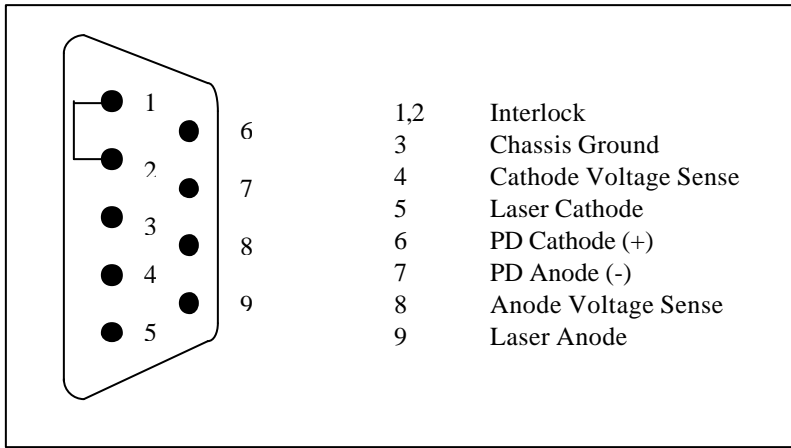

Figure 2.2 Back Panel LD Connector

Interlock Connections

In order for the laser output to be enabled, a short must exist between the Interlock pins (pins 1 and 2) of the connector. The short can be a direct short across the pins or a switch to prevent laser operation until the switch is closed. If a short does not exist between these two pins and you attempt to turn on the LAS output, an error (E501) will be indicated on the display for the respective channel, on any of the Laser set up pages, or on the status screen; furthermore, the output will be turned off.

CAUTION

The interlock terminals on the LASER connector, pins 1 and 2, must be kept isolated from all other connections including earth ground.

Four-Wire Voltage Sense

The LDC-3916370 Series Modules have a 4-wire voltage sense feature. The laser voltage is sensed through a pair of connections (pins 4 and 8) that is separate from the laser current drive connections (pins 5 and 9). This allows a more accurate laser voltage reading for the voltage limit feature. All four of these pins (4,5,8,9) must be connected for the module to operate. See Tech Note #TN3916-2 for more information on 4-wire Voltage Sense.

Photodiode Connections

Many laser diode modules contain an internal photodiode that monitors the back-facet emission of the laser. Usually, this photodiode is internally connected to either the laser anode or cathode.

The photodiode and laser connections to the LDC-3916370 Series Laser Diode Controller Module are electrically isolated from ground and each other. So, if a 4-pin connection is made (no common connections) no additional jumpers are required. Figures 2.1A - 2.1D show the recommended connections and shielding for 3-pin lasers (where the common connection is internal to the device). A 4-pin laser should be connected with the same shielding as shown in Figure 2.1, but the common connection (between the photodiode and the laser) is optional.

Grounding Considerations

The LASER outputs of the LDC-3916370 Series Laser Diode Controller Module are isolated from chassis ground allowing either output terminal to be grounded at the user's option. Figure 2.1 shows the proper earth-ground shielding for laser diode/photodiode connections.

CONNECTING TO THE TEC CONTROLLER

The 15 pin connector on the rear panel of your Controller module (top connector) is used to make connections to the thermoelectric cooler (TEC) modules of your laser or laser mount, and the temperature sensor. There are connections provided for TEC module, temperature sensor, earth ground, and analog ground. The pin-out diagram for this connector is shown in Figure 2.3.

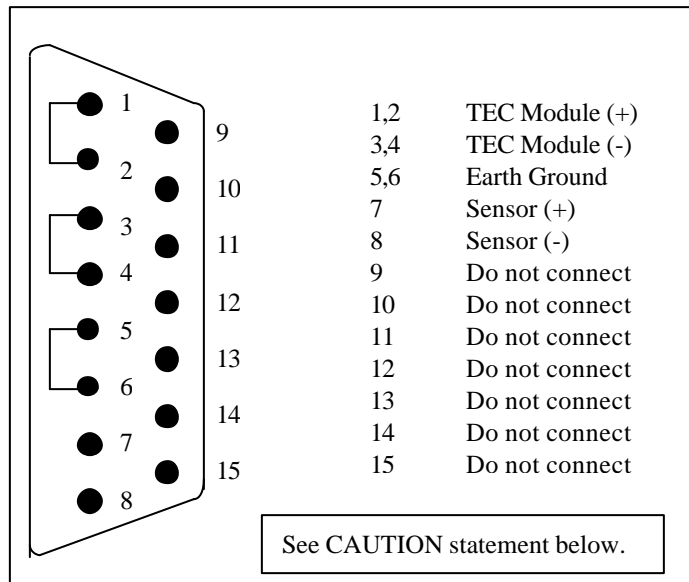

Figure 2.3 Rear Panel TEC Connector

Current will flow from pins 1 and 2 to pins 3 and 4 when the controller is trying to cool the load. This is referred to as “positive” current. Current will flow in the opposite direction when the controller is trying to heat the load. Pins 5 and 6 are connected to the 3916 chassis, which is connected to earth ground through the power cord. Thermistor sensor current (10 or 100 μ A) flows from pin 7 to pin 8, which develops a voltage for calculating thermistor resistance. **Pins 9-15 are reserved by ILX Lightwave for diagnostics purposes and must not be connected to anything in your system.**

TEC Grounding Considerations

The TEC outputs of your LDC-3916370 Series Laser Diode Controller Modules are isolated from chassis ground, allowing either output terminal to be grounded at the user's option if desired (see caution statement below).

CAUTION

Do NOT allow Sensor (-) to connect to TEC Module (-) or TEC Module (+) directly or through a common ground. Even a momentary connection when the output is off will cause damage to the instrument and/or device. For the TEC connector, if any one terminal pin is grounded, then no other terminal pin should be grounded. Instrument damage caused by shorting these pins is not covered under warranty.

OPERATING THE LASER CURRENT SOURCE FROM THE FRONT PANEL

The various laser current source control parameters can be set the same for all of the channels via the **All Chnl** menu which is accessed through the **MAIN** menu. Alternatively, the laser source control parameters for each individual channel can be set independently via the **LAS** channel setup menu, which is accessed through the **CHAN** menu. You can move between multiple pages of any setup menu by pushing the up and down arrow soft keys (F3 and F4) while in the setup menu. Which parameter to adjust can be selected with the **(DISPLAY) UP/DOWN ARROW** keys. In general, the selected parameter value can be adjusted with the numeric keypad, the **ADJUST** knob, or the **(ADJUST) UP/DOWN ARROW** keys. The **ENTER** key must be pressed within three seconds after entering a numeric value with the keypad, or the value will revert to the previous value.

The **DISPLAY** is used to show both the set point and measured value of laser control parameters such as laser drive current (Iset and Io), laser current limit (Ilim), laser forward voltage (Vf), forward voltage limit (Vlim), mode of control (Mode), monitor photodiode current (Ipdset and Ipd), and laser optical power (Plim and Ppd). It will also display error codes, which relate to **LASER** operation. Error codes indicate control errors and are explained below in the section titled “**LASER ERROR INDICATORS**”.

The following sections describe fundamentals of single channel operation for your LDC-3916370 Series Controller Module’s Laser Diode Current Source in two operating modes, Constant Current (I) and Constant Power (P).

OPERATING A LASER IN CONSTANT CURRENT (I) MODE

Suppose you have an LDC-3916370 Series Controller Module and you want to run the instrument in Constant Current low bandwidth mode (I_{lbw}), with a set point of 150 mA, a current limit of 175 mA, and a voltage limit of 6 volts. The I_{lbw} mode uses a low-pass filter on the laser drive current output to significantly reduce noise. In this mode a low bandwidth modulation input may be used via the back panel **MODULATION** connector. Follow the instructions below, in the sequence presented, to program the current source for a single channel.

Entering the Laser Channel Setup Menu



Push the **CHAN** key to display the single channel menu. From this menu you can see the measured parameters, enter the **LAS** or **TEC** channel setup menus, or turn the **LAS** current source and/or **TEC** on and off. Use the **(ADJUST) UP/DOWN ARROW** keys or the **ADJUST** knob to select the desired channel number highlighted at the top of the display. Push the **DISPLAY LAS** soft key (F2) to enter page 1 of the laser channel setup menu.

Selecting the Mode of Control



Select the **Mode** parameter by pushing the **(DISPLAY) UP/DOWN ARROW** keys until the **Mode** parameter is highlighted. Repeatedly pushing the **(ADJUST) UP/DOWN ARROW** keys or turning the **ADJUST** knob will cycle through the Constant Current low bandwidth (I_{lbw}), Constant Optical Power (P), Constant Current high bandwidth (I_{hbw}), and Photodiode Current (I_{pd}) control modes. Set the LDC-3916370 Series Controller Modules in Constant Current low bandwidth mode by selecting the **I_{lbw}** mode.

Setting the Current Limit



Now select the current limit (**Ilim**) parameter using the **(DISPLAY) UP/DOWN ARROW** keys. Adjust the value to 175mA. The current limit protects your laser by never allowing the laser drive current to exceed the Ilim value independent of the current set point and the controller mode (Constant Current or Constant Power).

CAUTION

Failure to set and ensure a proper Ilim value could result in laser damage.

Setting the Constant Current Value



Next, select the **Iset** parameter on the setup menu using the **(DISPLAY) UP/DOWN ARROW** keys. This parameter sets the laser current source drive value when in I1bw or I1bhw modes. Enter 150 mA using the numeric keypad, the **ADJUST** knob, or the **(ADJUST) UP/DOWN ARROW** keys. Push the **ENTER** key to store the value in memory within three seconds after entering the value using the numeric keypad, or it will revert to the old value.

Setting the Voltage Limit



Select the voltage limit (**Ulim**) parameter and adjust it to 6 volts in the same manner as described above. The voltage limit also protects your laser by shutting off the source driver if the laser voltage exceeds the **Ulim** value. The **Ulim** value should be set slightly above the operating voltage of the laser diode to provide maximum protection.

NOTE

There is also a laser optical power limit (Plim) safety feature explained in this manual under the section titled "OPERATING A LASER IN CONSTANT POWER MODE, P". The laser optical power limit can be disabled by setting the CalPD value to zero on page 2 of the laser setup menu.

Enabling the Modulation Input



Change the display to LAS p.3 of the laser setup menu to set the next parameter. Do this by pushing the **DOWN** soft key (F4) twice. The **Modulation** parameter on this page controls whether the MODULATION connector input is active or not. Select the **Modulation** parameter by pressing the **(DISPLAY) UP/DOWN ARROW** keys until the **Modulation** parameter is highlighted. Adjust the value to ON or OFF as desired with the **(ADJUST) UP/DOWN ARROW** keys or the **ADJUST** knob. Refer to the LDC-3916370 Series Controller Module specifications for modulation input specifications and limitations.

Setting Photodiode Bias Voltage



The **Bias** parameter setting controls whether a 5 volt reverse voltage is supplied to the monitor photodiode or not. Set the **Bias** parameter to ON or OFF as desired.

Many laser diode modules are tested and characterized by the manufacturer with a 5 volt reverse bias on the photodiode. This bias can decrease the response time and increase the linearity and/or saturation level of the photodiode.

Turning the Laser Current Source On

Now you are ready to enable the current source output for your laser diode on this channel. You can enable this channel now or set all of the other channels first. The top soft key (F1) on any of the three pages of the LAS setup menu will toggle the laser current source on and off. You can also turn the current source on and off with the top soft key (F1) on the CHAN menu. The ON toggle has a two second delay before the current source is enabled in compliance with safety requirements.

Each single channel current source can be turned on or off independently as described above, or you can turn on all the channel sources at the same time from the **All Chnl** menu. See the LDC-3916 Mainframe Instruction Manual for more information on the all channel operation.

OPERATING A LASER IN CONSTANT POWER (P) MODE

Suppose you want to operate a 3 mW laser in constant optical power at 1 mW. The LDC-3916370 Series Controller Modules allow you to operate the instrument current source drivers in Constant Optical Power (P) mode. In the “P” mode, the controller drives current to the laser to reach a set power value in mW. The control loop feedback parameter is monitor photodiode current, which the controller converts to optical power via a user defined photodiode responsivity number, CalPD. If laser power changes due to internal or environmental conditions, the controller will increase/decrease the current to the laser to maintain the power set point. The following paragraphs detail the instrument configuration in Constant Power Mode.

Calculating Photodiode Responsivity Values

The photodiode responsivity, **CalPD**, is used to convert between photodiode current and optical power of the laser diode. A method to calculate the responsivity is suggested below.

1. Measure (with a calibrated detector) the output power of the laser.
2. Measure the corresponding monitor photodiode current.
3. Calculate the responsivity (CalPD) by dividing the photodiode current by the optical power noting the units required are $\mu\text{A}/\text{mW}$.

Entering the Laser Channel Setup Menu



To enter the setup menu, push the **CHAN** key, which displays the channel menu. Select the correct channel number at the top of the display by pushing the **(ADJUST) UP/DOWN ARROW** keys or turning the **ADJUST** knob. Then push the **DISPLAY LAS** soft key (F2) to enter page 1 of the laser setup menu.

Selecting the Mode of Control



Select the **Mode** parameter by pushing the **(DISPLAY) UP/DOWN ARROW** keys until the **Mode** parameter is highlighted. Repeatedly pushing the **(ADJUST) UP/DOWN ARROW** keys or turning the **ADJUST** knob will cycle through the Constant Current low bandwidth (llbw), Constant Optical Power (P), Constant Current high bandwidth (Ihbw), and Photodiode Current (Ipd) control modes. Set the LDC-3916370 Series Controller Module in Constant Optical Power mode by selecting the **P** mode.

Setting the Current Limit



Select the laser current limit (**Ilim**) parameter by pushing the **(DISPLAY) UP/DOWN ARROW** keys until the **Ilim** value is highlighted with the cursor. Adjust the current limit value with the numeric keypad, the **ADJUST** knob, or the **(ADJUST) UP/DOWN ARROW** keys. If you use the numeric keypad, you must push the **ENTER** key to store the value in memory within three seconds after entering the value, or it will revert to the previous value. The current limit protects your laser by never allowing the laser drive current to exceed the **Ilim** value independent of the current set point and the controller mode (Constant Current or Constant Power).

CAUTION

*Failure to set and ensure a proper **Ilim** value could result in laser damage.*

Setting the Voltage Limit



Next, select the laser voltage limit (**Vlim**) parameter using the **(DISPLAY) UP/DOWN ARROW** keys. Adjust this value to your desired laser voltage limit. The voltage limit also protects your laser by shutting off the source driver if the laser voltage exceeds the **Vlim** value. The **Vlim** value should be set slightly above the operating voltage of the laser diode to provide maximum protection.

NOTE

*Be sure to push the **ENTER** key within three seconds after using the keypad to adjust any numeric values in the setup menus; otherwise, the value will revert to the previous setting.*

Setting the Power Limit



Now push the **DOWN** soft key (F4) to advance to LAS p.2 of the laser setup menu. Before the laser is enabled, the power limit for the laser under test should be set. To do this, push the **(DISPLAY) UP/DOWN ARROW** keys to select the power limit (**Plim**) parameter. Adjust this value to your desired laser optical power limit. The responsivity value (**CalPD**) must be set to the correct value for the power limit feature to work properly. This is a software limit only. The LASER output is normally turned off if this limit is reached.

Adjusting the Constant Power Setting



Use the **(DISPLAY) UP/DOWN ARROW** keys to select the power (**Pset**) parameter, and adjust the value to 1 mW. The Controller Module will divide the measured photodiode current by the **CalPD** value to calculate the laser optical power. The current source will automatically adjust the laser drive current to keep the calculated laser power at the **Pset** value.

Setting the Responsivity Value (CalPD)



The correct responsivity value (**CalPD**) must be set for the constant power mode to operate properly. To do this, select the **CalPD** parameter, and adjust it to the correct value. The **CalPD** units are $\mu\text{A}/\text{mW}$.

A method to calculate the responsivity value (CalPD) is suggested here:

- Measure (with a calibrated detector) the output power of the laser.
- Measure the corresponding monitor photodiode current.
- Calculate the responsivity (CalPD) by dividing the photodiode current by the optical power noting the units required are $\mu\text{A}/\text{mW}$.

Setting the Photodiode Bias Voltage



Now push the **DOWN** soft key (F4) to display LAS p.3 of the laser setup menu. The **Bias** parameter setting controls whether or not a bias voltage is applied to the monitor photodiode. Select the **Bias** parameter and adjust it ON or OFF depending on whether you want a 5 volt reverse bias on your photodiode or not. (Many laser diode modules are tested and characterized by the manufacturer with a 5 volt reverse bias on the photodiode. This bias can decrease the response time and increase the linearity and/or saturation level of the photodiode.)

Enabling the Modulation Input



The **Modulation** parameter on the LAS p.3 setup menu controls whether the MODULATION connector input is active or not. Select the **Modulation** parameter by pressing the **(DISPLAY) UP/DOWN ARROW** keys until the **Modulation** parameter is highlighted. Adjust the value to ON or OFF as desired. Refer to the LDC-3916370 Series module specifications in chapter 1 for modulation input specifications and limitations.

Constant Power Mode If CalPD is Unknown



If you do not know the correct photodiode responsivity (CalPD) value, the LDC-3916370 Series Modules can still drive your laser at a constant light power. The Constant Photodiode Current (**Ipd**) mode will control the laser drive current so the monitor photodiode current remains at a constant set point. To do this, adjust the **Mode** to **Ipd** on LAS p.1 of the laser setup menu, **and** set the photodiode current (**Ipdset**) parameter on the LAS p.2 menu to your desired value. In this case, you may want to set the power limit (**Plim**) value high or set **CalPD** to zero which will disable the power limit feature. Be sure to set the **Ilim** and **Vlim** values on LAS p.1 of the laser setup menu to protect your laser.

Turning the Laser Current Source On

Now this channel is configured to operate in Constant Power Mode. The Controller's laser current source will drive the laser to the Constant Power set point and maintain closed loop control with the monitor photodiode current measurement. You can enable this channel now or set all of the other channels first. The top soft key (F1) on any of the three pages of the LAS setup menu will toggle the laser current source on and off. You can also turn the current source on and off with the top soft key (F1) on the channel menu. The ON toggle has a two second delay before the current source is enabled in compliance with safety requirements.

Each single channel current source can be turned on or off independently as described above, or you can turn on all the channel sources at the same time from the **All Chnl** menu. See the LDC-3916 Mainframe Instruction Manual for more information on all channel operation.

CONDITIONS WHICH WILL AUTOMATICALLY SHUT OFF THE LASER OUTPUT

When the LASER output is off, an internal short is placed across the LASER output. The default condition for the current source output is OFF when the instrument is first powered up. With the laser output enabled, the channel or status displays should be indicating measured laser current. If the output won't function or an error code appears, check the conditions shown below or table 2.3 "LASER Error Indicators".

The following conditions will automatically force the laser current source to turn off:

1. LASER High Power Limit (Plim, E507)
2. LASER High Voltage Limit (Vlim, E503 or E505)
3. LASER ENABLE Interlock (E501)
4. LASER ENABLE Key Lock turned off on the front panel (E501)
5. LASER Open Circuit (E503)
6. TEC High Temperature Limit Condition (E509)

In addition, the LASER Current Limit setting (Ilim) will clip the laser drive current at the Ilim set point when the signal is being modulated. When the LASER current limit (Ilim) is reached, an ILIM warning will appear on the CHAN menu display. The current limit setting is independent of the voltage drop of the device connected to the LASER output. Furthermore, since the current limit circuitry is fully independent of the main current control, the current limit can be adjusted safely, even while the LASER output is active.

The LDC-3916370 Series Controller Modules' response to sensing the various limits can be controlled via the GPIB interface. Most high limit responses can be set to either turn off the source or just give a limit warning through the GPIB interface. See the "LAS:ENAB:OUTOFF" command in chapter 4 of this manual for more information.

Laser Error Indicators

The LDC-3916370 Series Laser Diode Current Source Controllers indicate general LASER operational error conditions. When an error occurs, the Error Indicator Code will appear on the Status page, the Chan page, or the LAS Setup pages for the respective channel. The Error Indicator Code will clear if you exit any page that it appears on. The output drive will shut off when any laser error occurs. Laser Error Indicator codes are summarized in Table 2.3. Some of these errors can be disabled using GPIB: see Chapter 4 for more information. See table 2.4 for TEC Error Code Indicators, and chapter 3 in the LDC-3916 mainframe manual for mainframe error codes.

<u>Error Condition</u>	<u>Probable Cause</u>
E501 Interlock	Interlock pins not connected properly or LASER ENABLE key lock turned off on front panel.
E503 Voltage limit or Open circuit	The laser current source or voltage measurement pins are open, or some condition caused the laser voltage to reach the limit value (Vlim).
E504 Current limit	The current limit (Ilim) was reached. This condition will cause Error Indicator Code E504 and shut down the source only when enabled through the GPIB interface; otherwise, a current limit will only clip the drive current at the Ilim value and indicate ILIM on the display.
E505 Voltage limit warning	The voltage on the laser current source is approaching the Vlim value. This condition will cause Error Indicator Code E505 and shut down the source only when enabled through the GPIB interface.
E507 Output Power Limit	Software calculated optical output power limit (Plim) was detected.
E508 TEC is off	TEC source has turned off for some reason. This condition will cause Error Indicator Code E508 and shut down the laser source only when enabled through the GPIB interface.
E509 TEC temperature limit	Software calculated TEC temperature limit (TLim) was detected.
E510 Tolerance event	Out of tolerance status forces LAS output off.
E511 Hardware error	Hardware has detected an error.
E529 Output off when controller thinks it is on	Laser source is off without hardware or software indicating a reason.
E535 Mode changed while output on	Operating mode was changed while the laser current source was on.

Table 2.3 LASER Error Indicators

OPERATING THE TEC CONTROLLER FROM THE FRONT PANEL

This section describes how to operate your LDC-3916370 Series Controller Module's Temperature Controller in Constant Temperature Mode, **T**. There are three modes in which you can operate the temperature controller: Constant Temperature (T), Constant Thermistor Resistance (R), and Constant TEC Current (I). Operating in Constant Temperature Mode is presented in the following sections, however the same operating principles apply to the other operating modes.

The various temperature control parameters can be set the same for all channels via the **ALL CHAN** menu, which is accessed through the **MAIN** menu. Alternatively, the temperature control parameters for each individual channel can be set independently via the **TEC** channel setup menu, which is accessed through the **CHAN** menu. You can move between multiple pages of any setup menu by depressing the up and down arrow soft keys, F3 and F4, while in the setup menu. Which parameter to adjust can be selected with the **(DISPLAY) UP/DOWN ARROW** keys. In general, the selected parameter value can be adjusted with the numeric keypad, the **(ADJUST)** knob, or the **(ADJUST) UP/DOWN ARROW** keys. If you use the numeric keypad, the **ENTER** key must be pressed within three seconds after entering any numeric value, or the value will revert to the previous value.

The display is used to show both the set point and measured value of TEC control parameters such as temperature (Tset and T), thermoelectric module current (Iset and I), temperature limit (TLim), thermoelectric module current limit (Ilim), controller mode, thermoelectric module forward voltage (Vt), sensor resistance (R), temperature control loop gain (Gain), sensor current range (10 μ A or 100 μ A), and sensor constants (C1, C2, and C3).

Selecting the TEC Control Setup Menu



To access any of the TEC Control setup menus, you must start with the channel menu. This can be accomplished in several ways; the most direct way is to depress the **CHAN** hard key right below the **MAIN** key. Here you can select the desired channel by turning the **(ADJUST)** knob or pushing the **(ADJUST) UP/DOWN ARROW** keys. Press soft key **F4 (TEC)** to access the first page of the three TEC setup menu pages.

OPERATING THE CONTROLLER IN CONSTANT TEMPERATURE (T) MODE

Suppose you need to operate and temperature control a laser with an internal TEC module. The maximum TEC module operating current for this device is 1.5 Amps. A typical operating mode would be to control the laser diode temperature to 25 °C with the temperature sensor type being a 10 K Ω thermistor. In this experiment, the maximum operating temperature will be 40 °C. To configure the LDC-3916370 Series Temperature Controller, you will need to select the sensor current range, enter the correct thermistor constants, select the Temperature Control mode, set the control loop gain, and set appropriate temperature and TEC module current limits.

To enter the TEC setup menu, push the **CHAN** key, then the **TEC** soft key (F4).

Selecting the TEC Control Mode



Set the LDC-3916370 Series Temperature Controller to Temperature Control mode by selecting **T** in the **MODE** section of the display on **TEC p.1**. Use the **(DISPLAY) UP/DOWN ARROW** arrow hard keys until the **MODE** parameter is highlighted. Repeatedly pushing the **(ADJUST) UP/DOWN ARROW** hard keys or turning the **ADJUST UP/DOWN ARROW** knob will cycle through the available instrument modes **T** (constant temperature), **I** (constant TEC current), and **R** (constant thermistor resistance). Set the temperature controller in Constant Temperature Mode by selecting the **T** mode.

Setting the Temperature Limit

Now, let's set the temperature limit to 40°C. The temperature limit function (**TLim**) sets the maximum temperature the controller will allow before generating an error condition and disabling the TEC and laser outputs. During controller operation, if this limit is reached, the error indicator E407 will be shown on the display and the **LASER** and **TEC** outputs will be shut off to protect the laser.



To set the temperature limit to 40°C, use the **(DISPLAY) UP/DOWN ARROW** keys to highlight the **TLim** value. Next, use the **(ADJUST) UP/DOWN ARROW** keys, knob, or the keypad to enter the desired value of 40 °C.

NOTE

*When using the keypad to enter a numeric value, be sure to push the **ENTER** key within three seconds, otherwise the value will revert to the previous setting.*

Adjusting the Temperature Set Point

Now adjust the set point operating temperature of the controller to 25 °C. The temperature controller will monitor actual temperature and adjust TEC current to maintain the thermal load at the set point temperature.



To adjust the Temperature Set Point to 25 °C, use the **(DISPLAY) UP/DOWN ARROW** key to highlight the **Tset** value. Next, use the **(ADJUST) UP/DOWN ARROW** keys, knob, or the keypad to enter the desired value of 25 °C.

Setting TEC Current Limit

The TEC Current Limit protects your TEC by limiting the controller's output current so that the instrument does not provide more current than your TEC module can safely handle. During controller operation, if the TEC current limit is reached, the warning, **ILim** will be shown on the display. The TEC current limit is set in Amps.

NOTE

The thermoelectric module current limit condition is a normal operating condition of the temperature controller module. This limit condition will cause error indication E404 and shut down the source current only when enabled through GPIB; otherwise the current limit will clip the source current at the limit value.



To set the TEC current limit to 1.5 Amps, first select **TEC p. 2** by pushing the down soft key (**F4**) on the **TEC p. 1** menu. Use the (**DISPLAY**) **UP/DOWN ARROW** keys to highlight the **ILim** value. Next, use the (**ADJUST**) **UP/DOWN ARROW** keys, knob, or the keypad to enter the desired value of 1.5 amps (A).

The **Rset** and **Iset** parameters on **TEC p.2** are used in the Constant Thermistor Resistance and Constant TEC Current Modes.

Setting TEC Control Loop Gain

For best temperature control loop performance, the control loop gain needs to be set. The GAIN function sets the analog feedback gain which, in part, determines how fast the actual temperature reaches and settles to the set point temperature. If the gain is set too low, the TE cooler will take longer to reach the temperature set point. If it is set too high, the actual temperature may overshoot and may oscillate around the set temperature resulting in long temperature settling times. The allowed GAIN values in the LDC-3916370 Series Temperature Controller are from 1 to 127 in steps of 1. These values define the proportional loop gain of our hybrid PI temperature control loop.

The gain setting depends on the type of TEC module and thermal load that you are using, but we can suggest guidelines for selecting the proper gain. Set the gain to 30 and increase it until the actual temperature oscillates around the set temperature. Then reduce the gain to the next lower value.



To adjust the **GAIN** value, first select **TEC p.3** by pushing the down soft key (**F4**) on **TEC p.2**. Then use the (**DISPLAY**) **UP/DOWN ARROW** keys to highlight the **GAIN** number. To change the value, use the (**ADJUST**) **UP/DOWN ARROW** keys, knob, or the keypad to enter the desired value. The quickest way would be to use the keypad for large changes in gain values. Set the temperature control loop **GAIN** value to **30**.

Temperature Controller Sensor Selection

Because we have selected a 10 k Ω thermistor as our temperature sensing element and we have chosen 25°C as our set point temperature, we need to set the **SENSOR** range to **100 mA**.

Your LDC-3916370 Series Temperature Controller operates in a closed loop fashion with a temperature sensor being the feedback element. The only temperature sensor allowed for these controller modules is the thermistor type. Thermistor resistances are rated at room temperature. In this case, we are using a 10 k Ω thermistor, which means that at 25°C the resistance value of the thermistor is 10,000 ohms (10 k Ω). For the controller to operate accurately, the correct range of sensor needs to be selected.

Thermistor resistance changes with temperature. A constant current source integrated into the controller supplies current through the thermistor, in this case 100 μ A, so that a temperature change results in a voltage change across the thermistor ($V=IR$). This voltage change is sensed by the controller and fed back to the control loop. The 10 μ A and 100 μ A designations are current levels supplied by the controller. The selected supply current depends on the thermistor operating temperature range and the required temperature resolution. A general rule of thumb for a 10 k Ω thermistor is to use the 10 μ A range for temperatures between -30 and +30 °C, and the 100 μ A range for temperatures between +10 °C to +70 °C. For a more complete description of thermistor selection see our Application Note #2 titled, "Selecting and Using Thermistors for Temperature Control".



To set the temperature controller's **Sensor** range, use the **(DISPLAY) UP/DOWN ARROW** keys until the **SENSOR** parameter is highlighted. Repeatedly pushing the **(ADJUST) UP/DOWN ARROW** hard keys or turning the **ADJUST** knob will cycle through the available thermistor current modes of **100 mA** and **10 mA**. Set the temperature controller in **100 mA** sensor range.

Setting Temperature Sensor Constants

For accurate temperature control, it will be necessary to enter the sensor calibration constants into the controller for accurate conversion of sensor resistance to actual temperature. These constants are used in a temperature conversion equation to calibrate the TEC, and are usually supplied with your thermistor's data sheet. The Steinhart-Hart equation is used to derive temperature from the non-linear resistance of an NTC (Negative Temperature Coefficient) thermistor. The constants are displayed on **TEC p.3**.



To adjust the value of a C1, C2, or C3 constant, use the **(DISPLAY) UP/DOWN ARROW** keys to highlight the desired constant name (**C1**, **C2**, or **C3**). To change the value, use the **(ADJUST) UP/DOWN ARROW** keys, knob, or the keypad to enter the desired value. The range of values for C1, C2, and C3 are -99.9999 to +99.9999. The quickest way would be to use the keypad for large changes in constant values

When all the TEC parameters are set to the desired values, the output of the temperature controller can be enabled. With the output enabled the temperature controller will drive current to the TEC modules to cool or heat the load depending on the difference between the set point and the actual temperature. Press the soft key **F1** once to enable the **TEC** output, and again to disable the output. The display soft key enunciator will toggle from off to on to off by repeatedly depressing the soft key. The default condition for the **TEC** output is off when the instrument is first powered up. Other conditions which will disable the **TEC** output are listed in the next section.

Conditions Which Will Automatically Shut Off the TEC Output

The following conditions will automatically cause the instrument to turn off the TEC output when the default settings are used. Some responses to limit and error conditions can be changed through GPIB control. See Chapters 3 and 4 for more information.

1. High Temperature Limit reached (E407)
2. Sensor Open (while output is enabled, E402)
3. TEC Module Open (while output is enabled, E403)
4. Sensor Range Changed (while output is on, E409)
5. Sensor Shorted (while output is on, E415)
6. TEC Mode Changed (while output is on, E435)

TEC ERROR INDICATORS

The LDC-3916370 Series Controllers indicate general TEC operational error conditions. When an error occurs, the Error Indicator Code will appear on the Status page, the Chan page, or the respective channel's setup pages. The Error Indicator Code will clear if you exit any page that it appears on. TEC Error Indicator Codes are summarized in Table 2.4. Some of these errors can be disabled using GPIB. See chapter 4 for more information. See table 2.3 for Laser Error Indicator Codes, and chapter 3 in the LDC-3916 mainframe manual for mainframe error codes.

<u>Error Number</u>	<u>Error Condition</u>	<u>Probable Cause</u>
E402	Open Sensor	An open circuit has been detected in the thermistor connections. Check the connections to the thermistor and to pins 7 and 8 on the 15-pin connector.
E403	TEC Module Open	An open circuit has been detected in the TEC module connections. Check the wires and connections to the TEC module, and to pins 1,2 and 3,4 on the controller's 15-pin connector.
E404	TEC Current Limit	The controller reached the current limit, and the "current limit" bit of the Output Off Enable register has been set using GPIB.
E405	Voltage Limit	The output driver has reached its voltage limit and the "voltage limit" bit of the Output Off Enable register has been set using GPIB.
E407	Temperature Limit	The measured temperature has reached the high-temperature limit setting.
E409	Sensor Changed (with output enabled)	The sensor current source range was changed during operation of the temperature controller while the output was enabled. The TEC output only is disabled and the error condition is displayed.
E410	Tolerance error	The output dropped out of tolerance, and the "Tolerance" bit in the Output Off Enable register has been set.
E415	Sensor Shorted	The measured thermistor resistance is less than 25 Ω , and the "Sensor Shorted" bit in the Output Off Enable register has been set.
E435	Mode Changed	The TEC mode was changed while the TEC output was on.

Table 2.4 TEC Error Indicators

The errors that are enabled in the "Output Off Enable" register by default at power-up are Open Sensor, TEC Module Open, Temperature Limit, and Sensor Shorted. The Output Off Enable register is not saved at power-down.

CHAPTER 3	1
OPERATING IN REMOTE CONTROL	1
INTRODUCTION	1
REMOTE CONFIGURATION	1
LDC-3916370 SERIES LASER DIODE CONTROLLER COMMAND SET	1
LDC-3916370 Series Laser Diode Controller Often Used Commands	3
Command Timing and Completion	4
STATUS REPORTING	4
Status Registers	4
Output Off Registers	8
Error Messages	11

CHAPTER 3

OPERATING IN REMOTE CONTROL

INTRODUCTION

Everything you can do from the front panel can also be done remotely and in some cases with more flexibility. For example, in remote mode, you can enable or disable conditions that will cause the laser current source or the TEC controller to automatically shut off. The following sections show you the fundamentals of operating your LDC-3916370 Series module remotely through the GPIB and RS-232 interfaces.

REMOTE CONFIGURATION

Refer to the LDC-3916 Instruction Manual Chapter 3, “Operating in Remote Control” for information concerning setup of GPIB or RS-232 remote communications. That section also describes the use of IEEE 488.2 common commands, LDC-3916 mainframe commands, and syntax.

LDC-3916370 SERIES LASER DIODE CONTROLLER COMMAND SET

The LDC-3916370 Series module utilizes its own module-specific commands, as well as the commands for the LDC-3916 mainframe (see LDC-3916 Instruction Manual Chapter 3 “Operating in Remote Control”). Figure 3.1 shows all of the commands which are usable by the LDC-3916 in conjunction with the LDC-3916370 Series modules.

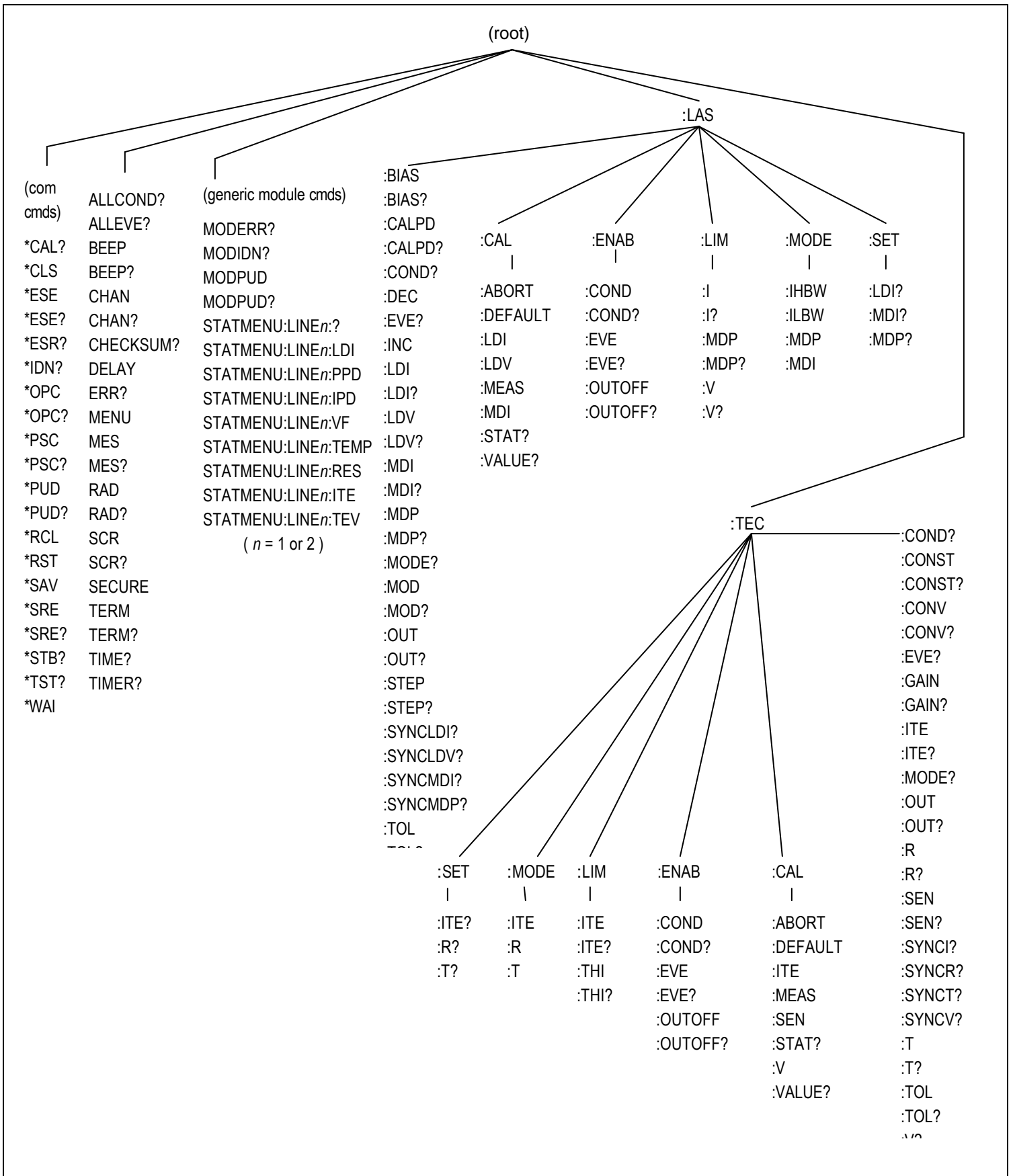

Figure 3.1 LDC-3916 and LDC-3916370 Series Laser Diode Controller Command Path Structure

LDC-3916370 Series Laser Diode Controller Often Used Commands

The LDC-3916370 Series Laser Diode Controller's complete command set contains over 100 commands that allow you to operate the controller for a variety of applications. Within the command set, however, is a smaller subset of commands that will meet most of your needs. These commands are listed in Table 3.1.

LDC-3916370 Series Often Used Commands

NAME	PARAMETERS	FUNCTION
CHAN	1	Sets the channel (or ALL channels) for further commands.
ERR?	NONE	Returns "Mainframe" errors generated since the last query, followed by a binary representation of existing module errors.
MODERR?	NONE	Returns module errors generated since the last error query (to that module).
STATMENU:LINE <i>n</i> ?	NONE	Returns the name of the measurement that is displayed on line <i>n</i> of the status menu. (<i>n</i> can be either 1 or 2).
STATMENU:LINE <i>n</i> :LDI	NONE	Sets line <i>n</i> of the status menu to display laser current
STATMENU:LINE <i>n</i> :VF	NONE	Sets line <i>n</i> of the status menu to display laser forward voltage.
STATMENU:LINE <i>n</i> :IPD	NONE	Sets line <i>n</i> of the status menu to display photodiode current.
STATMENU:LINE <i>n</i> :PPD	NONE	Sets line <i>n</i> of the status menu to display optical power.
STATMENU:LINE <i>n</i> :TEMP	NONE	Sets line <i>n</i> of the status menu to display tec temperature.
STATMENU:LINE <i>n</i> :ITE	NONE	Sets line <i>n</i> of the status menu to display tec current.
STATMENU:LINE <i>n</i> :RES	NONE	Sets line <i>n</i> of the status menu to display thermistor resistance.
STATMENU:LINE <i>n</i> :TEV	NONE	Sets line <i>n</i> of the status menu to display tec forward voltage.
LASER		
LAS:CALPD	1	Sets the monitor photodiode responsivity for Power mode use.
LAS:LDI	1	Sets the LAS constant current source set point value.
LAS:LDI?	NONE	Returns the constant current source measured value.
LAS:LDV?	NONE	Returns the measured laser voltage value.
LAS:LIM:I	1	Sets the LAS current source limit.
LAS:LIM:MDP	1	Sets the constant optical power (from monitor PD) limit value.
LAS:LIM:V	1	Sets the LAS current compliance voltage limit.
LAS:MDP	1	Sets the constant optical power set point.
LAS:MDP?	NONE	Returns the actual monitor PD power value.
LAS:MODE:IHBW	NONE	Sets the mode to constant current, high bandwidth mode.
LAS:MODE:ILBW	NONE	Sets the mode to constant current low bandwidth mode.
LAS:MODE:MDP	NONE	Sets the mode to constant optical power mode.
LAS:OUT	1	Used to enable/disable the current source output.
LAS:OUT?	NONE	Returns the current source output status.
TEC CONTROLLER		
TEC:CONST	3	Used to enter temperature sensor constants, C1, C2, C3.
TEC:GAIN	1	Sets the TEC control loop gain parameter.
TEC:LIM:ITE	1	Sets the TEC current limit value.
TEC:LIM:THI	1	Sets the TEC upper temperature limit value.
TEC:MODE:R	NONE	Sets the instrument to constant (sensor) reference mode.
TEC:MODE:T	NONE	Sets the instrument to constant temperature mode.

Table 3.1 LDC-3916370 Series Often Used Commands (cont.)

LDC-3916370 Series Often Used Commands

NAME	PARAMETERS	FUNCTION
TEC:OUT	1	Used to enable/disable the TEC output.
TEC:OUT?	NONE	Returns the TEC output status.
TEC:SEN	1	Sets the SENSOR type for TEC feedback.
TEC:T	1	Sets the TEC (temperature) set point.
TEC:T?	NONE	Returns the TEC measured temperature value.
TEC:V?	NONE	Returns the TEC measured voltage value.

Table 3.1 LDC-3916370 Series Often Used Commands

Command Timing and Completion

All commands for the LDC-3916370 Series modules are sequential, except for the “LAS:OUT ON”, “LAS:INC”, and “LAS:DEC” commands. The “LAS:OUT ON” command is overlapped to allow the user to abort it with the “LAS:OUT OFF” command during a two second interval after the output is told to be on. The “LAS:INC” and “LAS:DEC” commands are overlapped to allow the user to monitor the other functions while in an automatic ramping mode.

For more information on the use of operation complete commands, such as *WAI and *OPC, refer to the LDC-3916 Instruction Manual, Chapter 3.

STATUS REPORTING

Refer to the LDC-3916 Laser Diode Controller Instruction Manual, Chapter 3 “Operating in Remote Control” for information on standard status structures, mainframe-related commands, and for understanding the Operation Complete definition.

The following sections discuss the LDC-3916370 Series module-dependent aspects of the status reporting, including the “OUTOFF” commands and queries. The Output Off Register section also contains information on specifying some of the conditions that will force the laser current source and/or TEC output off.

Status Registers

The LDC-3916370 Series modules provide status registers which are summarized in the LDC-3916 mainframe. These summaries are accessed by the “ALLCOND?” and “ALLEVE?” remote queries. Refer to the LDC-3916 Instruction Manual for details on remote status reporting.

Each channel of the LDC-3916 may contribute to the “ALLCOND” and “ALLEVE” registers. For the LDC-3916370 Series modules, the enabled conditions of both the LAS and TEC functions are logically ORed, and the summary is passed to the appropriate bit of the ALLCOND register (see Figure 3.2). Likewise, the enabled events of both the LAS and TEC functions are logically ORed, and the summary is passed to the appropriate bit of the ALLEVE register (see Figure 3.3).

For example, you may wish to have the LDC-3916 create an interrupt to the host PC in the event of the TEC output shutting off. To do this you would first enable the event with the “TEC:ENAB:EVE 1024” command. This would allow the event to be passed to the ALLEVE register on the 3916 mainframe. The ALLEVE status can be read by the “ALLEVE?” query and the summary can be monitored with the “*STB?” query. To generate the SRQ (interrupt) for

our example, you must also set the Service Request Enable Register, e. g. “*SRE 1”, to allow the ALLEVE summary to generate the interrupt. See the LDC-3916 Instruction Manual, Chapter 3, for details on status structures.

NOTE

When the laser voltage reaches the voltage limit setting (LAS:LIM:V), the hardware will always shut the laser output off. The "Laser Voltage Limit" referred to in the Event, Condition, and Output Off Registers occurs when the voltage is about 0.25 volts less than the voltage limit setting. This feature can be used for a warning before the actual voltage limit is reached.

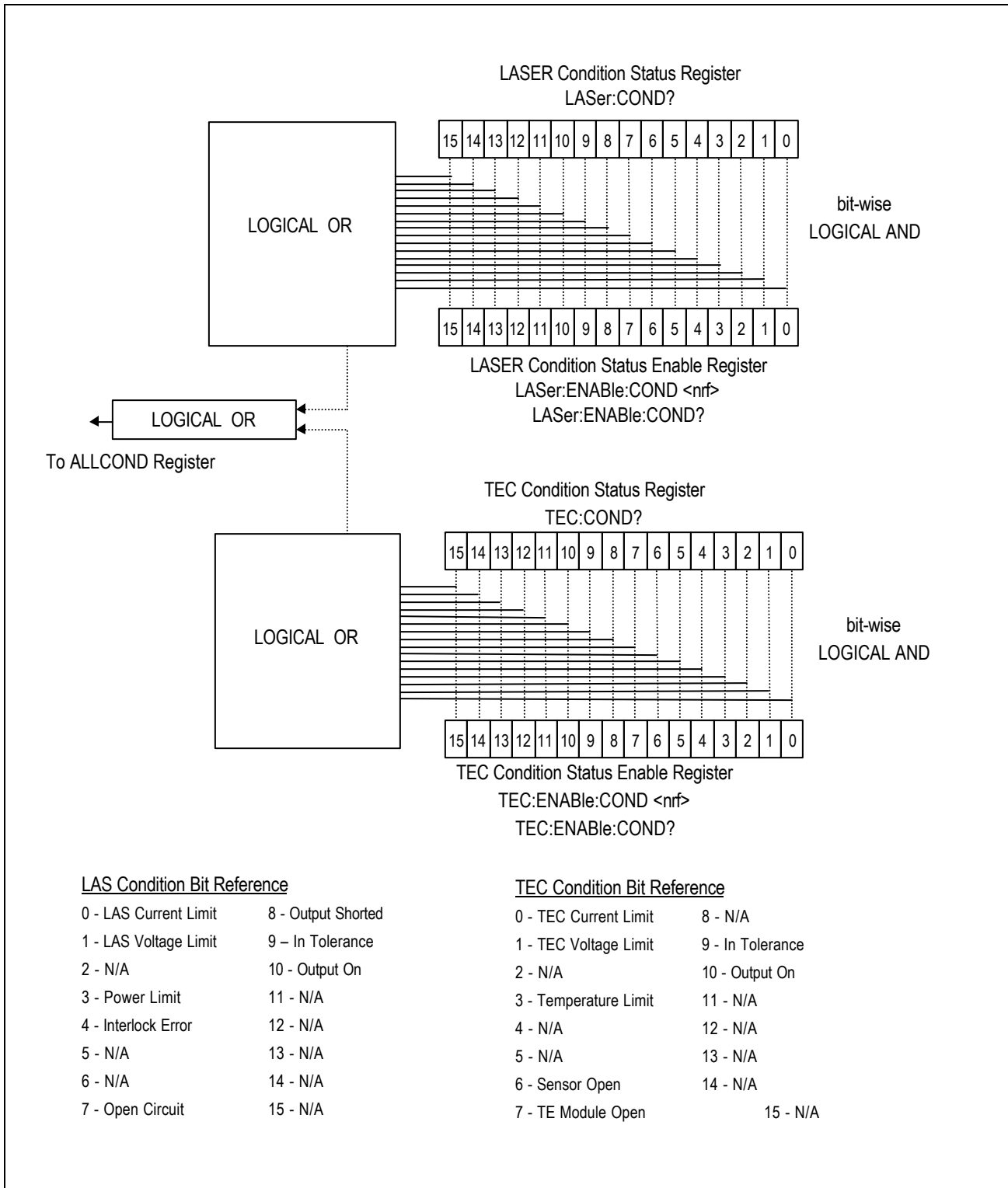

LAS Condition Bit Reference

- | | |
|-----------------------|--------------------|
| 0 - LAS Current Limit | 8 - Output Shorted |
| 1 - LAS Voltage Limit | 9 - In Tolerance |
| 2 - N/A | 10 - Output On |
| 3 - Power Limit | 11 - N/A |
| 4 - Interlock Error | 12 - N/A |
| 5 - N/A | 13 - N/A |
| 6 - N/A | 14 - N/A |
| 7 - Open Circuit | 15 - N/A |

TEC Condition Bit Reference

- | | |
|-----------------------|------------------|
| 0 - TEC Current Limit | 8 - N/A |
| 1 - TEC Voltage Limit | 9 - In Tolerance |
| 2 - N/A | 10 - Output On |
| 3 - Temperature Limit | 11 - N/A |
| 4 - N/A | 12 - N/A |
| 5 - N/A | 13 - N/A |
| 6 - Sensor Open | 14 - N/A |
| 7 - TE Module Open | 15 - N/A |

Figure 3.2 3916370 Series Condition Registers

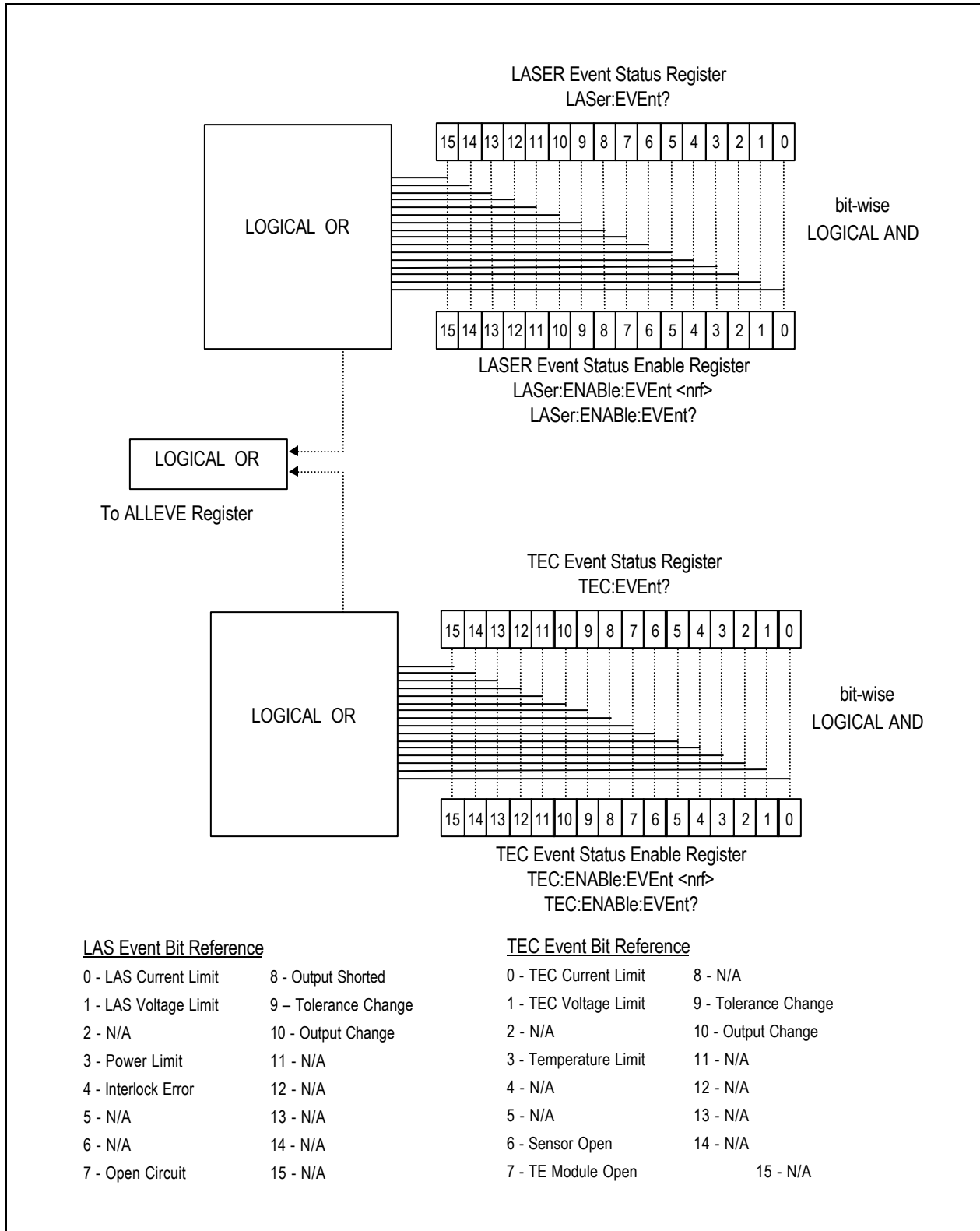

Figure 3.3 3916370 Series Event Registers

Output Off Registers

The Output Off Enable Registers allow you to determine which conditions and events in the TEC and LASER controllers can cause their outputs to be turned off. These registers are configured in a manner which is similar to the status reporting registers. However, their values are not reported in the Status Byte Register. These registers are used by the firmware to control the output enable for that function (LASER or TEC). The events and conditions which may be set to cause the TEC and LASER outputs to be turned off are shown in Figures 3.4 and 3.5.

The default settings for these registers for an LDC-3916370 Series module are shown in Table 3.2. The registers take on these values at power-up, as the result of a *RST command, or when you choose “Default” from the Save/Recall menu. These settings are not affected by the *PSC (Power-On Status Clear) command.

DEFAULT SETTINGS FOR OUTPUT OFF ENABLE REGISTERS

<u>LASER Output Off Register</u>			<u>TEC Output Off Register</u>		
Bit	Name	State	Bit	Name	State
0	Current Limit	Disabled	0	Current Limit	Disabled
1	Voltage Limit	Disabled	1	Voltage Limit	Disabled
2	N/A		2	N/A	
3	Power Limit	Enabled	3	High Temperature Limit	Enabled
4	N/A		4	N/A	
5	N/A		5	N/A	
6	N/A		6	Sensor Open	Enabled
7	N/A (see Note 1 below)		7	TE Module Open Circuit	Enabled
8	N/A		8	Sensor Type changed	Enabled
9	Out of Tolerance	Disabled	9	Out of Tolerance	Disabled
10	TEC Output Off	Disabled	10	Sensor Shorted	Enabled
11	TEC High Temp Limit	Enabled	11	N/A	
12	N/A		12	N/A	
13	N/A		13	N/A	
14	N/A		14	N/A	
15	N/A		15	N/A	

Table 3.2 LDC-3916370 Series Default Settings for Output Off Registers

Note 1: Bit 7 is Laser Open Circuit in the Laser Condition and Event registers. It is not available to disable in the Output Off Enable register because it is always active in the hardware.

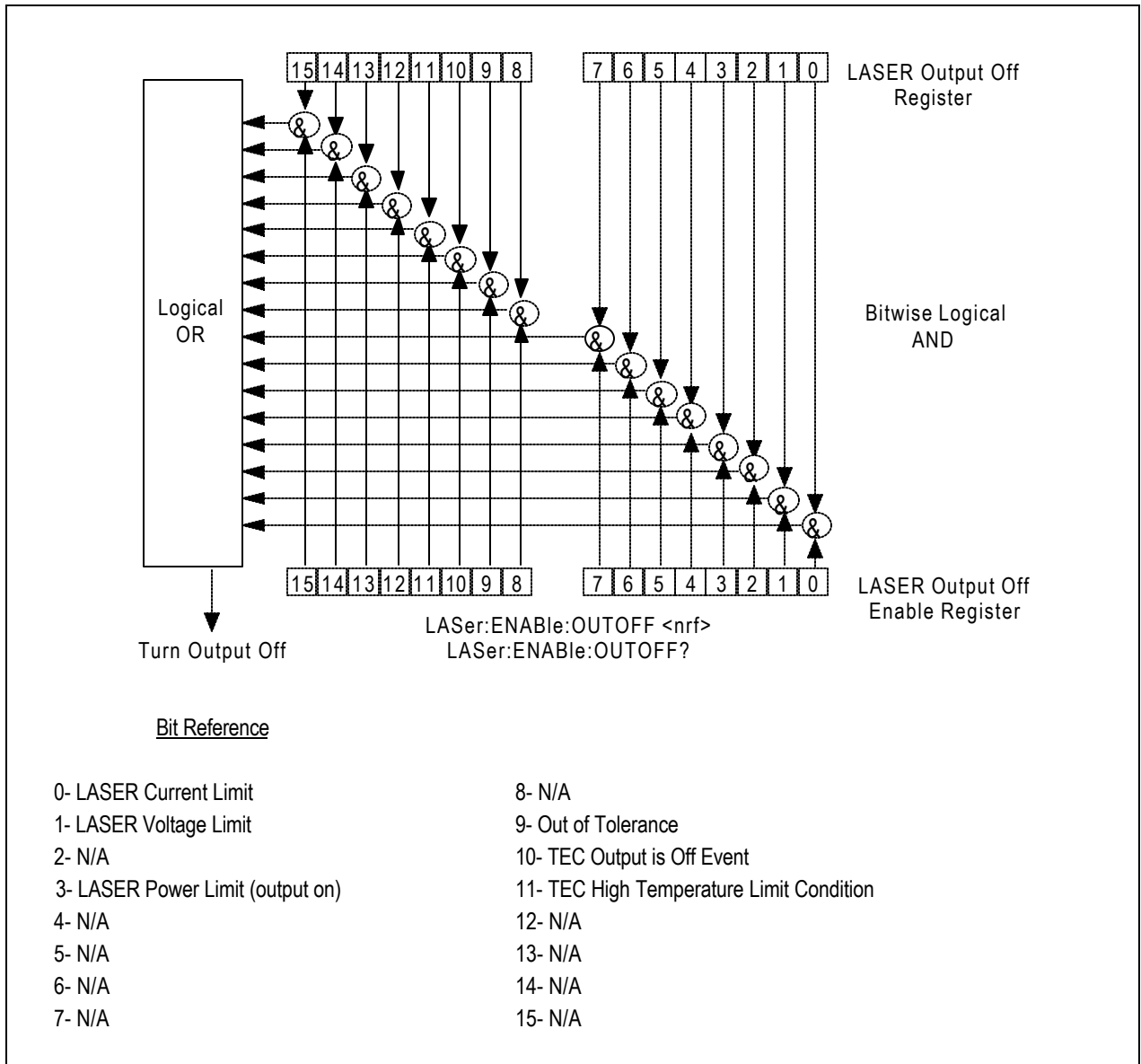

Figure 3.4 LDC-3916370 Series Laser Diode Controller LASER Output Off Register

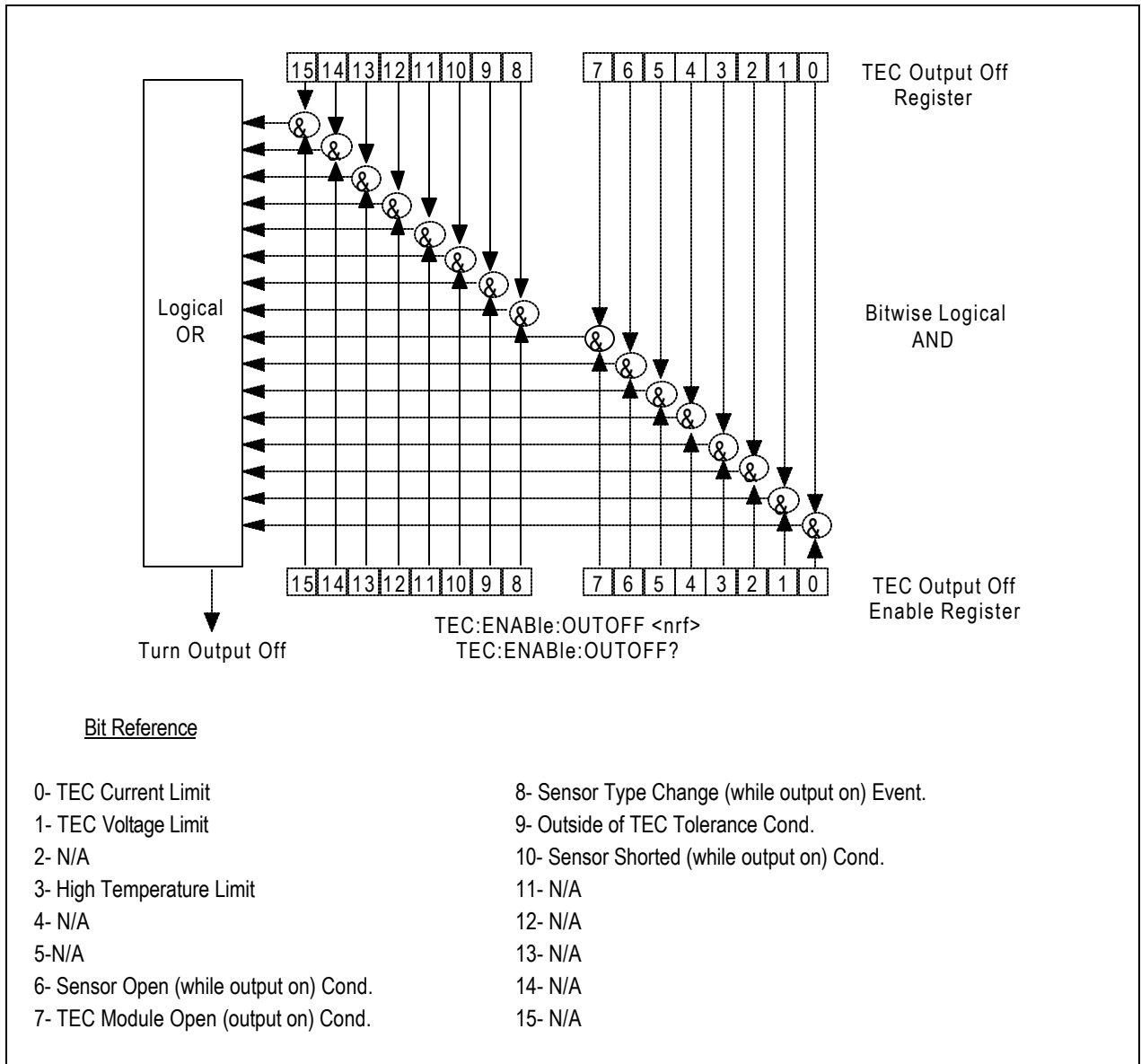

Figure 3.5 LDC-3916370 Series Laser Diode Controller TEC Output Off Register

Error Messages

This section contains descriptions of the errors which are specific to the LDC-3916370 Series modules. These are the error codes that are returned from the “MODERR?” query. Refer to the LDC-3916 Laser Diode Controller Instruction Manual, Chapter 3, for a list of LDC-3916 mainframe error codes and descriptions (the codes returned from the “ERR?” query).

During remote operation, the recommended method for error testing is as follows. First read the system errors and module error summary with the “ERR?” query. This allows you to error check the LDC-3916 as a whole. If any module errors are present, the corresponding bit of the error summary will be set. For example, if the “ERR?” query returns “0,0001000000100000” there are errors on channels 13 and 6. Then read the module errors using the “MODERR?” query. For example, “Chan 13;Moderr?” and “Chan 6;Moderr?” queries could be sent. For more information on LDC-3916 mainframe errors, refer to Chapter 3 of the LDC-3916 Instruction Manual.

LDC-3916370 SERIES ERROR MESSAGES

<u>Error Code</u>	<u>Explanation</u>
E-103	Length of arbitrary block is different from expected length.
E-104	Parameter is an undefined numeric type.
E-105	Parameter has an invalid exponent.
E-106	A digit was expected in the parameter but was not found.
E-114	Specified arbitrary block length is invalid.
E-123	Command is not found.
E-126	Wrong number of parameters for command.
E-201	Parameter value out of range.
E-202	Error in conversion of parameter type.
E-203	Command is a "secure" command, but secure commands are disabled.
E-205	Expected Boolean parameter is invalid.
E-206	Error in conversion to signed 16-bit integer.
E-207	Error in conversion to unsigned 16-bit integer.
E-209	Error in conversion to unsigned 32-bit integer.
E-210	Error in conversion to floating-point number.
E-214	Response is too long to output.
E-220	Programmable User Data specification invalid.
E-221	Internal error: message undeliverable.
E-222	Set value is over range.
E-223	Set value is under range.

Table 3.3 LDC-3916370 Series Error Message Codes

(continued next page)

<u>Error Code</u>	<u>Explanation</u>
E-402	Sensor open forces TEC output off.
E-403	Module Open forces TEC output off.
E-404	TE Current Limit forces TEC output off.
E-405	TE Voltage Limit forces TEC output off.
E-407	High Temperature Limit forces TEC output off.
E-409	Sensor Changed while output enabled; TEC output forced off.
E-410	Out of Tolerance status forces TEC output off.
E-415	Sensor Shorted forces TEC output off.
E-435	TEC Operating Mode changed while output on; TEC output forced off.
E-501	Interlock Open forces LAS output off.
E-503	LAS forward voltage exceeds Voltage Limit setting; LAS output forced off. (Open Circuit error)
E-504	LAS Current Limit forces LAS output off.
E-505	LAS forward voltage approaching Voltage Limit setting; LAS output forced off.
E-507	LAS Power Limit forces LAS output off.
E-508	TEC Output Off Status forces LAS output off.
E-509	TEC Temperature Limit forces LAS output off.
E-510	Out of Tolerance Status forces LAS output off.
E-511	LAS Hardware Error forces LAS output off.
E-512	A TEC source, such as a 3916558 or 3916545, which has been programmed to control this laser module has turned off for some reason. This condition will shut down the laser source when enabled.
E-513	A TEC source, such as a 3916558 or 3916545, which has been programmed to control this laser module has turned off because it reached the temperature limit. This condition will shut down the laser source when enabled.
E-529	LAS Output is off, but LAS status thought it was on.
E-535	LAS Operating Mode changed while output on; LAS output forced off.
E-601	Internal error: recalled setting has incorrect checksum (settings do not match bin).
E-710	Internal error: internal sensor #1 over-temperature forces Las output off.
E-711	Internal error: internal sensor #2 over-temperature forces Las output off.
E-712	Internal error: internal sensor #3 over-temperature forces Las output off.
E-802	Calibration Measurement Entered Before Calibration was Ready.
E-803	Attempted to Enter Invalid Calibration Mode.

Table 3.3 LDC-3916370 Series Error Message Codes

CHAPTER 4	1
COMMAND REFERENCE	1
INTRODUCTION	1
LDC-3916370 SERIES DEVICE-DEPENDENT COMMANDS	5
LDC-3916370 SERIES DEVICE-COMMAND REFERENCE	5

CHAPTER 4

COMMAND REFERENCE

INTRODUCTION

This chapter is a guide to all of the device-dependent commands for the LDC-3916370 Series Laser Diode Controller module. This chapter is divided into two parts. The first part contains an overview of the remote commands used by the LDC-3916370 Series. The second part contains all of the LDC-3916370 Series commands in alphabetical order. Figure 4.1 shows the format for the device command descriptions in this chapter. The commands which emulate local (front panel) operation are denoted by the solid box next to the Local label in the upper left corner of the command description.

LDC-3916370 Series Device-Dependent Commands

<u>NAME</u>	<u>PARAMETERS</u>	<u>FUNCTION</u>
LAS:BIAS	1	Enables or disables the -5 volt photodiode bias.
LAS:BIAS?	NONE	Returns the status of the photodiode bias control.
LAS:CALPD	1	Used to set the CAL PD (monitor responsivity) constant.
LAS:CALPD?	NONE	Returns the CAL PD (monitor responsivity) constant.
LAS:CAL:ABORT	NONE	Aborts a LAS calibration.
LAS:CAL:DEFAULT	NONE	Restores all LAS calibration values to their defaults.
LAS:CAL:LDI	NONE	Enters the laser current calibration mode.
LAS:CAL:LDV	NONE	Enters the laser voltage calibration mode.
LAS:CAL:MDI	NONE	Used to enter the monitor photodiode current calibration mode.
LAS:CAL:MEAS	1	Enters a calibration value.
LAS:CAL:STAT?	NONE	Returns a value which represents the calibration status.
LAS:CAL:VALUE?	1	Used for factory calibration testing only.
LAS:COND?	NONE	Returns the value of the LASER condition register.
LAS:DEC	2	Decreases the laser set point value by one or more steps with user-programmable delay between steps.
LAS:ENAB:COND	1	Sets the enable register for LASER conditions.
LAS:ENAB:COND?	NONE	Returns the value of the LAS conditions enable register.
LAS:ENAB:EVE	1	Sets the enable register for LAS events.
LAS:ENAB:EVE?	NONE	Returns the value of the LAS event enable register.
LAS:ENAB:OUTOFF	1	Sets the enable register for LAS conditions which turn the LAS output off.
LAS:ENAB:OUTOFF?	NONE	Returns the value of the LAS outoff enable register.
LAS:EVE?	NONE	Returns the value of the LAS event register.
LAS:LDI	1	Sets the LASER constant current source set point value.
LAS:LDI?	NONE	Returns the constant current source measured value

Table 4.1 LDC-3916370 Series Device-Dependent Commands

LDC-3916370 Series Device-Dependent Commands

<u>NAME</u>	<u>PARAMETERS</u>	<u>FUNCTION</u>
LAS:INC	2	Increases the laser set point value by one or more steps with user-programmable delay between steps.
LAS:LDV?	NONE	Returns the measured laser voltage value.
LAS:LIM:I	1	Sets the LASER current source limit.
LAS:LIM:I?	NONE	Returns the LASER current source limit.
LAS:LIM:MDP	1	Sets the constant optical power (from monitor PD) limit value.
LAS:LIM:MDP?	NONE	Returns the optical power (from monitor PD) limit value.
LAS:LIM:V	1	Sets the current source's adjustable compliance voltage.
LAS:LIM:V?	NONE	Returns the value of the adjustable compliance voltage setting.
LAS:MDI	1	Sets the monitor current set point.
LAS:MDI?	NONE	Returns the monitor PD current measured value.
LAS:MDP	1	Sets the constant optical power set point
LAS:MDP?	NONE	Returns the actual monitor PD power value
LAS:MODE?	NONE	Returns the mode, I (current), IHBW (high bandwidth), P (optical power) or MDI (constant monitor current).
LAS:MODE:IHBW	NONE	Sets the mode to constant current, high bandwidth.
LAS:MODE:ILBW	NONE	Sets the mode to constant current low bandwidth mode.
LAS:MODE:MDI	NONE	Sets the mode to constant monitor current mode (regardless of CALPD value).
LAS:MODE:MDP	NONE	Sets the mode to constant optical power mode.
LAS:MOD	1	Enables or disables the channel's modulation input.
LAS:MOD?	NONE	Returns the status of the channel's modulation input.
LAS:OUT	1	Enables/disables the current source output.
LAS:OUT?	NONE	Returns the current source output status.
LAS:SET:LDI?	NONE	Returns the laser constant I (current) set point.
LAS:SET:MDI?	NONE	Returns the laser constant optical power set point.
LAS:SET:MDP?	NONE	Returns the constant P (optical power) set point.
LAS:STEP	1	Sets the LASER set point step value.
LAS:STEP?	NONE	Returns the LASER set point step value.
LAS:SYNCLDI?	NONE	Synchronized measurement. Returns the laser current in mA.
LAS:SYNCLDV?	NONE	Synchronized measurement. Returns the laser voltage in volts.
LAS:SYNCMDI?	NONE	Synchronized measurement. Returns the monitor photodiode current in μ A.
LAS:SYNCMDP?	NONE	Synchronized measurement. Returns the optical power.
LAS:TOL	2	Sets the laser set point tolerance value and time period value.
LAS:TOL?	NONE	Returns laser set point tolerance value and time period value.
MODERR?	NONE	Returns the error codes (up to 10) from the module.
MODIDN?	NONE	Returns identification data from the module.
MODPUD	1	Used at factory to set calibration information.
MODPUD?	NONE	Returns factory set calibration information.

Table 4.1 LDC-3916370 Series Device-Dependent Commands (Cont.)

LDC-3916370 Series Device-Dependent Commands

NAME	PARAMETERS	FUNCTION
STATMENU:LINE n ?	NONE	Returns the name of the measurement that is displayed on line n of the status menu. (n can be either 1 or 2).
STATMENU:LINE n :LDI	NONE	Sets line n of the status menu to display laser current
STATMENU:LINE n :VF	NONE	Sets line n of the status menu to display laser forward voltage.
STATMENU:LINE n :IPD	NONE	Sets line n of the status menu to display photodiode current.
STATMENU:LINE n :PPD	NONE	Sets line n of the status menu to display optical power.
STATMENU:LINE n :TEMP	NONE	Sets line n of the status menu to display tec temperature.
STATMENU:LINE n :ITE	NONE	Sets line n of the status menu to display tec current.
STATMENU:LINE n :RES	NONE	Sets line n of the status menu to display thermistor resistance.
STATMENU:LINE n :TEV	NONE	Sets line n of the status menu to display tec forward voltage.
TEC:CAL:ABORT	NONE	Aborts a TEC calibration.
TEC:CAL:DEFAULT	NONE	Sets all of the TEC calibration values to defaults.
TEC:CAL:ITE	1	Enters the TEC current source calibration mode.
TEC:CAL:MEAS	1	Enters a calibration value.
TEC:CAL:SEN	1	Enters the sensor calibration mode
TEC:CAL:STAT?	NONE	Returns the status of the TEC calibration.
TEC:CAL:V	NONE	Enters the TEC voltage calibration mode.
TEC:CAL:VALUE?	1	Used for factory calibration testing only.
TEC:COND?	NONE	Returns the value of the TEC condition register.
TEC:CONST	3	Sets temperature sensor constants, C1, C2, and C3
TEC:CONST?	NONE	Returns the temperature sensor constant values.
TEC:CONV:R	1	Converts a resistance ($K\Omega$) to temperature ($^{\circ}C$).
TEC:CONV:R?	0 or 1	Returns the equivalent temperature ($^{\circ}C$) of the last conversion.
TEC:CONV:T	1	Converts a temperature ($^{\circ}C$) to resistance ($K\Omega$).
TEC:CONV:T?	0 or 1	Returns the equivalent resistance ($K\Omega$) of the last conversion.
TEC:ENAB:COND	1	Sets the enable register for TEC conditions.
TEC:ENAB:COND?	NONE	Returns the value of the TEC conditions enable register.
TEC:ENAB:EVE	1	Sets the enable register for TEC events.
TEC:ENAB:EVE?	NONE	Returns the value of the TEC event enable register.
TEC:ENAB:OUTOFF	1	Sets the enable register for TEC conditions which turn the TEC output off.
TEC:ENAB:OUTOFF?	NONE	Returns the value of the TEC outoff enable register.
TEC:EVENT?	NONE	Returns the value of the TEC event register.
TEC:GAIN	1	Sets the TEC control loop gain parameter.
TEC:GAIN?	NONE	Returns the TEC control loop gain parameter.
TEC:ITE	1	Sets the TEC current (ITE) set point.
TEC:ITE?	NONE	Returns the measured TEC current (ITE) value
TEC:LIM:ITE	1	Sets the TEC constant current source limit value.
TEC:LIM:ITE?	NONE	Returns the constant current source limit value.
TEC:LIM:THI	1	Sets the TEC upper temperature limit value.
TEC:LIM:THI?	NONE	Returns the TEC upper temperature limit value.
TEC:MODE?	NONE	Returns the mode, ITE (TEC current), R (sensor) or T (temperature).

Table 4.1 LDC-3916370 Series Device-Dependent Commands (Cont.)

LDC-3916370 Series Device-Dependent Commands

<u>NAME</u>	<u>PARAMETERS</u>	<u>FUNCTION</u>
TEC:MODE:ITE	NONE	Sets the mode to constant TEC current mode.
TEC:MODE:R	NONE	Sets the mode to constant thermistor resistance mode.
TEC:MODE:T	NONE	Sets the TEC mode to constant temperature mode.
TEC:OUT	1	Enables/disables the TEC current output.
TEC:OUT?	NONE	Returns the TEC OUTPUT status.
TEC:R	1	Sets the constant sensor resistance set point.
TEC:R?	NONE	Returns the measured thermistor resistance value.
TEC:SEN	1	Sets the SENSOR type.
TEC:SEN?	NONE	Returns the SENSOR type (value).
TEC:SET:ITE?	NONE	Returns the constant ITE (TEC current) set point.
TEC:SET:R?	NONE	Returns the constant R (thermistor resistance) set point.
TEC:SET:T?	NONE	Returns the constant T (temperature) set point.
TEC:SYNCl?	NONE	Synchronized measurement. Returns the TE current in amps.
TEC:SYNCR?	NONE	Synchronized measurement. Returns the thermistor resistance in k Ω .
TEC:SYNCT?	NONE	Synchronized measurement. Returns the thermistor temperature in $^{\circ}\text{C}$.
TEC:SYNCV?	NONE	Synchronized measurement. Returns the measured TE voltage in volts.
TEC:T	1	Sets the TEC constant T (temperature) set point.
TEC:T?	NONE	Returns the TEC measured temperature value.
TEC:TOL	2	Sets the TEC set point tolerance value and time period value.
TEC:TOL?	NONE	Returns the TEC set point tolerance value and time period value.
TEC:V?	NONE	Returns the TEC voltage measurement.

Table 4.1 LDC-3916370 Series Device-Dependent Commands.

LDC-3916370 SERIES DEVICE-DEPENDENT COMMANDS

This section contains all of the device-dependent commands for the LDC-3916370 Series Laser Diode Controller, listed in alphabetical order. Sub-sections for each path are presented, listing the commands which are legal for that path. See Chapter 3 Figure 3.1 for command path tree structure.

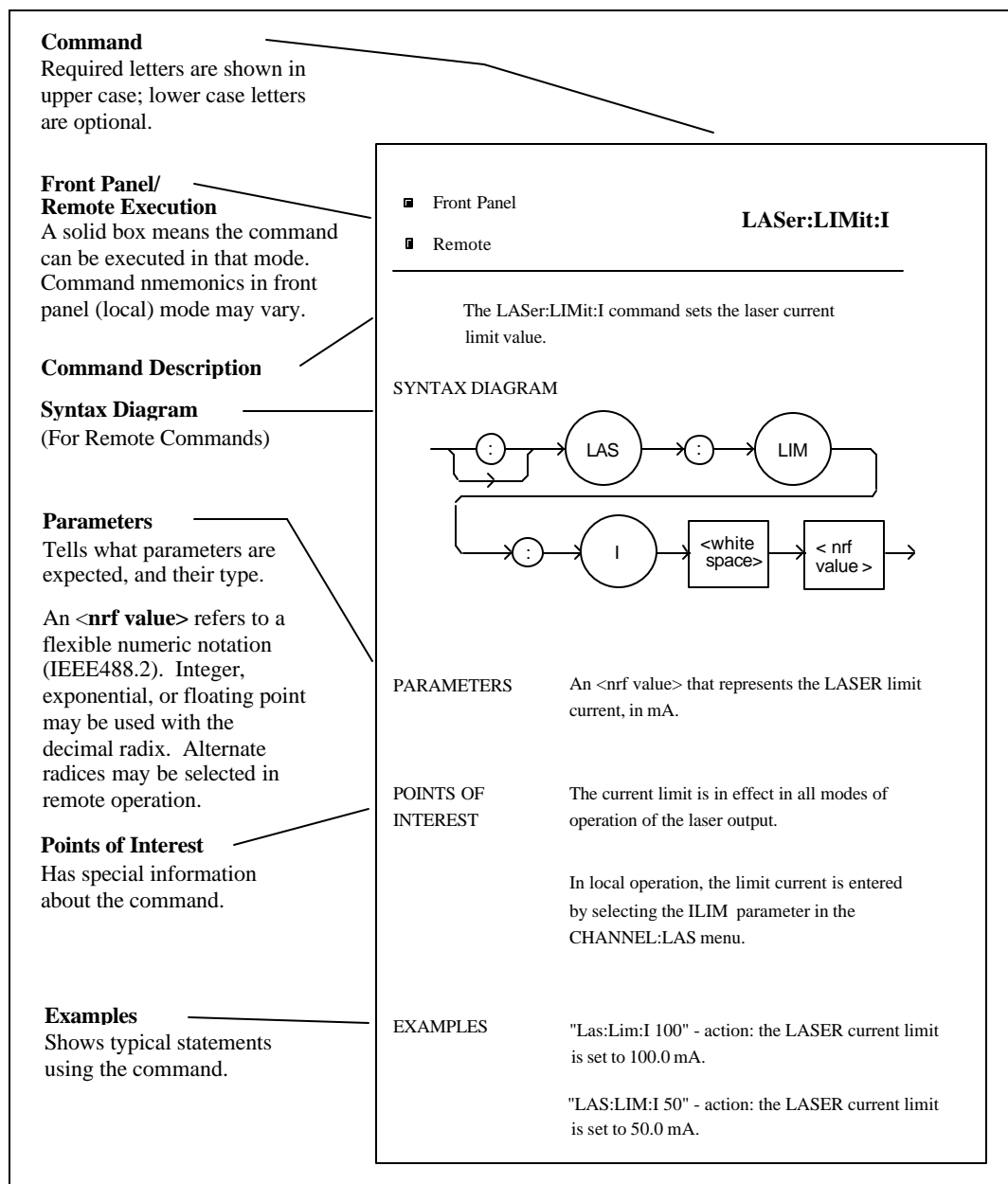

Figure 4.1 Command Description Format

LDC-3916370 SERIES DEVICE-COMMAND REFERENCE

The following pages contain a reference for the device-dependent commands of the LDC-3916370 Series Laser Diode Controller. This reference contains useful information for both local and remote operation of your Laser Diode Controller.

- Front Panel
- Remote

LASer:

The LASer: command path is used to get to the LDC-3916370 Series Laser Diode Controller's laser current source commands. The following command paths may be reached from the LASer: command path.

LASer:CAL:	LASer:MODE:
LASer:ENABLE:	LASer:SET:
LASer:LIMit:	

The following commands may be reached directly from the LASer: command path.

LASer:BIAS	LASer:LDV?	LASer:STEP
LASer:BIAS?	LASer:MDI	LASer:STEP?
LASer:CALPD	LASer:MDI?	LASer:SYNCLDI?
LASer:CALPD?	LASer:MDP	LASer:SYNCLDV?
LASer:COND?	LASer:MDP?	LASer:SYNCLMDI?
LASer:DEC	LASer:MODE?	LASer:SYNCLMDP?
LASer:EVEnt?	LASer:MODulation	LASer:TOL
LASer:INC	LASer:MODulation?	LASer:TOL?
LASer:LDI	LASer:OUTput	
LASer:LDI?	LASer:OUTput?	

- Front Panel
- Remote

LASer:BIAS

The LASer:BIAS command turns the selected channel's laser photodiode bias on or off.

SYNTAX DIAGRAM

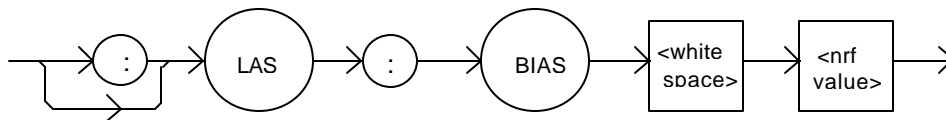

PARAMETERS An <nrf value>; 1 = on, 0 = off.

POINTS OF INTEREST When the BIAS is on, a bias of -5 volts is placed across the photodiode terminals.

EXAMPLES "LAS:BIAS ON" -action: sets the selected channel's laser photodiode bias output on.

"Las:Bias 0" -action: turns the selected channel's laser photodiode bias off.

- Front Panel
- Remote

LASer:BIAS?

The LASer:BIAS? query returns the status of the selected laser channel's photodiode bias selection.

SYNTAX DIAGRAM

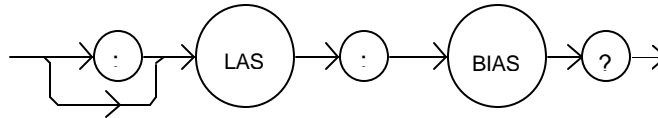

PARAMETERS None. The response is an <nrf value>.

POINTS OF INTEREST Photodiode bias is turned off when a *RST command is issued.

EXAMPLES "Las:BIAS?" -response: 0, means that the selected channel's photodiode bias is off.
 "LAS:Bias?" -response: 1, means that the selected channel's photodiode bias is enabled.

- Front Panel
- Remote

LASer:CALPD

The LASer:CALPD command sets the laser's photodiode feedback responsivity (the CAL PD parameter) on the selected channel.

SYNTAX DIAGRAM

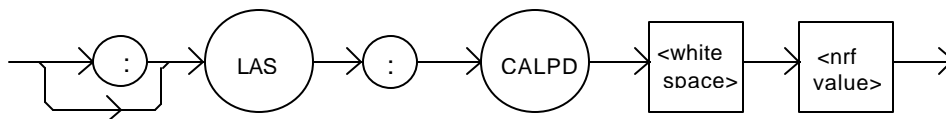

PARAMETERS An <nrf value>, in microamps/milliwatt.

POINTS OF INTEREST Optical power (PPD) is calculated as the monitor photodiode current divided by this value.

EXAMPLES "LAS:CALPD 0" -action: sets the CAL PD parameter to 0.
 "Laser:Calpd 1" -action: sets the CAL PD parameter to 1.00 microamp/milliwatt: a photodiode feedback current of 1 microamp will cause the P display to read 1 milliwatt.

- Front Panel
- Remote

LASer:CALPD?

The LASer:CALPD? query returns the value of the laser's photodiode feedback responsivity (CAL PD parameter) setting for the selected channel.

SYNTAX DIAGRAM

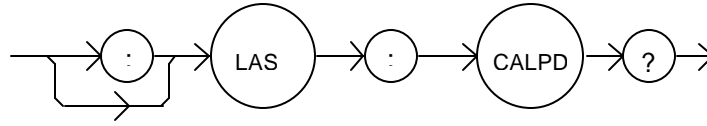

PARAMETERS None. The response is an <nrf value>.

POINTS OF INTEREST

If this value is 0, the selected channel's monitor current/power conversion will not be done. If the mode is set to MDP, the actual set point will be forced to be (near) 0, regardless of the LAS:MDP value.

If this value is 0, the front panel P will display "-----", and no P value can be calculated.

EXAMPLES

"LASer:CALPD?" -response: 0, means the selected channel's monitor current/power conversion will not be done. If the mode is set to P, the actual set point will be forced to be (near) 0, regardless of the LAS:MDP value.

"Las:CALPD?" -response: 1.1, means the selected channel is set for operation in constant P mode (if MDP mode is also selected) and the responsivity is set to 1.10 $\mu\text{A}/\text{mW}$. 1.1 μA of photodiode feedback current represents 1 mW of optical power.

- Front Panel
- Remote

LASer:CAL:

The LASer:CAL: command path is used to get to the selected channel's laser calibration commands.

The following commands may be reached directly from the LASer:CAL: command path.

```

LASer:CAL:ABORT
LASer:CAL:DEFAULT
LASer:CAL:LDI
LASer:CAL:LDV
LASer:CAL:MDI
LASer:CAL:MEAS
LASer:CAL:VALUE?
  
```

- Front Panel
- Remote

LASer:CAL:ABORT

The LASer:CAL:ABORT command is used to exit a Laser calibration without changing the calibration values.

SYNTAX DIAGRAM

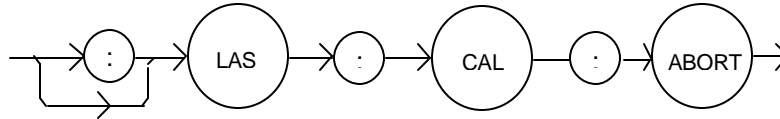

PARAMETERS None.

POINTS OF INTEREST

After this command is issued it is safe to run the LDC-3916370 Series Laser Diode Controller with the same calibration values used as before the LAS calibration mode was started.

This command is intended for use after a false or invalid calibration value is entered, or to exit calibration mode before any values have been entered.

EXAMPLES "Las:CAL:ABORT" -action: the LDC-3916370 Series Laser Diode Controller exits calibration mode.

- Front Panel
- Remote

LASer:CAL:DEFAULT

The LASer:CAL:DEFAULT command is used to restore all of the module's LAS calibration default values.

SYNTAX DIAGRAM

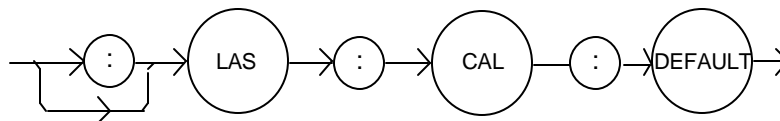

PARAMETERS None.

POINTS OF INTEREST

This command should not be used except when normal calibration procedures and/or normal operation of the LAS functions is not possible.

After this command is issued, the LAS module will not be calibrated. Each of the prescribed calibration procedures must be redone. The default values are the starting point values which exist before factory calibration is done.

EXAMPLES "Las:CAL:Default" -action: the LDC-3916370 Series Laser Diode Controller sets all of the LAS calibration values to defaults on the selected module.

- Front Panel
- Remote

LASer:CAL:LDI

The LASer:CAL:LDI command is used to enter the Laser current set point, measurement, and limit calibration mode for the selected channel.

SYNTAX DIAGRAM

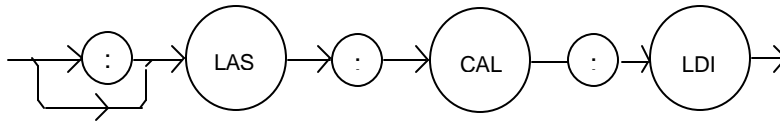

PARAMETERS None.

POINTS OF INTEREST

Since the limit circuit is the same for both high and low bandwidth modes, it is only calibrated once. Both low and high bandwidth are calibrated during this procedure.

After this command is issued, the LDC-3916370 Series Laser Diode Controller will allow calibration of the current set point, measurement, and limit. This procedure is outlined in the Calibration section of the Laser module instruction manual.

EXAMPLES

"Las:CAL:LdI" -action: the LDC-3916370 Series Laser Diode Controller enters calibration mode for Laser current.

"Las:Cal:LDI" -action: the LDC-3916370 Series Laser Diode Controller enters calibration mode for Laser current.

- Front Panel
- Remote

LASer:CAL:LDV

The LASer:CAL:LDV command is used to enter the Laser voltage measurement calibration mode for the selected channel.

SYNTAX DIAGRAM

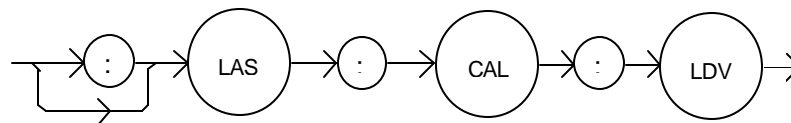

PARAMETERS None.

POINTS OF INTEREST

After this command is issued, the LDC-3916370 Series Laser Diode Controller will allow calibration of the laser voltage measurement. This procedure is outlined in the Calibration section of the Laser module instruction manual.

The "LAS:CAL:STAT?" query may be used to determine when the unit is ready for a calibration value to be entered.

EXAMPLES

"Las:CAL:Ldv" -action: the LDC-3916370 Series Laser Diode Controller enters calibration mode for Laser voltage.

"Las:Cal:LDV" -action: the LDC-3916370 Series Laser Diode Controller enters calibration mode for Laser voltage.

- Front Panel
- Remote

LASer:CAL:MDI

The LASer:CAL:MDI command is used to enter the Laser photodiode current calibration mode for the selected channel.

SYNTAX DIAGRAM

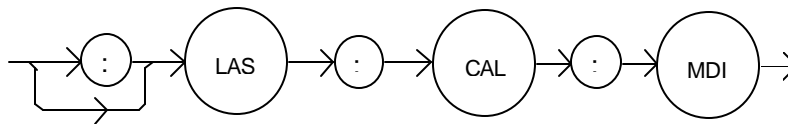

PARAMETERS

None.

POINTS OF INTEREST

After this command is issued, the LDC-3916370 Series Laser Diode Controller will automatically enter the Laser photodiode current calibration mode for the selected channel. When the LDC-3916370 Series Laser Diode Controller is ready, the user should enter true measured values. This procedure is outlined in the Calibration section of the Laser module instruction manual.

In remote operation, the LAS:CAL:STAT? query may be used to determine if the LDC-3916370 Series Laser Diode Controller is ready for the user to enter a value via the LAS:CAL:MEAS command.

EXAMPLES

"Las:CAL:MDI" -action: the LDC-3916370 Series Laser Diode Controller enters the Laser photodiode current calibration mode.

"Chan 1;LAS:Cal:MDI" -action: the LDC-3916370 Series Laser Diode Controller enters the Laser photodiode current calibration mode for channel 1.

- Front Panel
- Remote

LASer:CAL:MEAS

The LASer:CAL:MEAS command is used to enter the Laser calibration values for the selected channel.

SYNTAX DIAGRAM

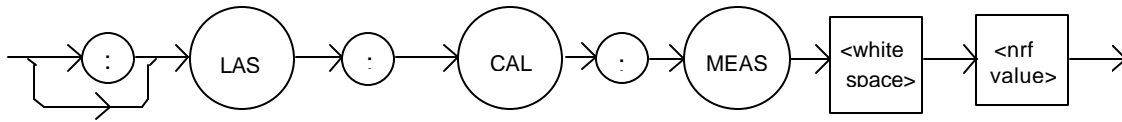

PARAMETERS An <nrf value> which represents the calibration value expected for the present LAS calibration state.

POINTS OF INTEREST In remote operation, the LAS:CAL:STAT? query may be used to determine if the LDC-3916370 Series Laser Diode Controller is ready for the user to enter a value via the LAS:CAL:MEAS command.

EXAMPLES "Las:CAL:MEAS 4.95" -action: the LDC-3916370 Series Laser Diode Controller enters the value 4.95 for calibration value of the present calibration mode.

- Front Panel
- Remote

LASer:CAL:STATus?

The LASer:CAL:STATus? query is to determine whether the unit is ready for a calibration value and whether it is in calibration mode.

SYNTAX DIAGRAM

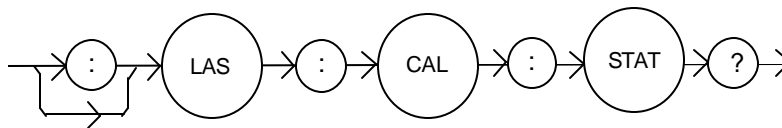

PARAMETERS None. The response will be an <nrf value>; 0 = Not Ready for Measurement, 1 = Ready for Measurement, 2 = Calibration Completed, and 3 = Calibration Aborted.

POINTS OF INTEREST If the calibration is aborted, the status value will remain "3" until the calibration is started again.

EXAMPLES "LAS:CAL:STAT?" -response: 1, means the LDC-3916370 Series Laser Diode Controller is ready for a calibration measurement to be entered via the "LAS:CAL:MEAS" command.

"LAS:CAL:STAT?" -response: 2, means the LDC-3916370 Series Laser Diode Controller has completed the LAS calibration.

"Las:Cal:Stat?" -response: 0, means the LDC-3916370 Series Laser Diode Controller is not yet ready for the LAS calibration measurement value to be entered.

- Front Panel
- Remote

LASer:CAL:VALUE?

The LASer:CAL:VALUE? query is used at the factory only.

- Front Panel
- Remote

LASer:COND?

The LASer:COND? query returns the value of the selected channel's Laser Condition Status register.

SYNTAX DIAGRAM

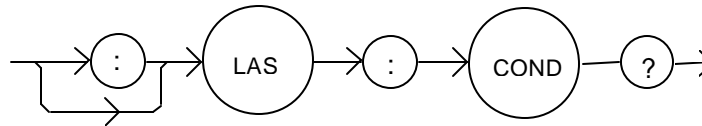

PARAMETERS None. The response is the sum of the following:

1 - Laser current limit	256 - Output is off
2 - Laser voltage limit	512 - Output In Tolerance
4 - N/A	1024 - Output is on
8 - Power limit	2048 - N/A
16 - Interlock disabled	4096 - N/A
32 - N/A	8192 - N/A
64 - N/A	16384 - N/A
128 - Open circuit	32768 - N/A

POINTS OF INTEREST

The Laser conditions which are reported to the status byte and ALLCOND register are set via the LASer:ENABLE:COND command (for each channel).

The Open circuit condition is only present while a Laser output is on, and when the hardware detects this condition, it will turn that Laser output off. Therefore, the Open Circuit condition is fleeting and may be missed via the LAS:COND? query. Therefore, the user should test for the Open Circuit Event via the LAS:EVEnt? query.

The Laser condition status is constantly changing, while the event status is only cleared when the event status is read or the *CLS or *RST command is issued.

NOTE

The voltage limit condition occurs as a warning when the voltage is about 0.25 volts below the VLIM setting.

EXAMPLES "LAS:COND?" -response: 1027, means that the output is on, and the current limit and voltage limit conditions currently exist.

The LASer:DEC command decrements the selected channel's laser constant-current set point by one or more steps. Parameters allow multiple steps to be decremented and the time (in milliseconds) between decrements to be set, respectively.

SYNTAX DIAGRAM

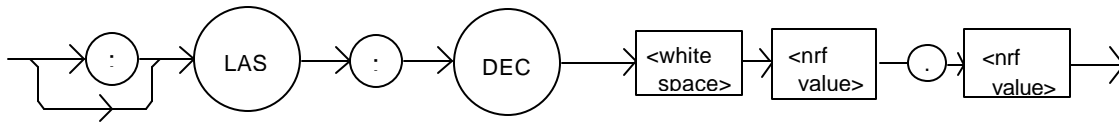

PARAMETERS Two <nrf values> are required. The first one represents the number of steps, and the second is the number of milliseconds between steps.

POINTS OF INTEREST The step size can be edited via the LAS:STEP command. Its default value is 1.0 mA.

The first parameter (number of steps) must be an integer between 1 and 50000.

The minimum time to complete one decrement is about 10 to 20 msec. Therefore, values for the second parameter (time between decrements) have a practical minimum of 20. The maximum number of msec is 65535.

Only the LAS:LDI set point is decremented via this command regardless of LAS:MODE setting or LAS:OUTPUT status.

EXAMPLES "LAS:STEP 0.3; LAS:DEC 1,10" -action: The laser source current set point is decremented by 0.3 mA.

"LAS:STEP 0.3; LAS:DEC 3,10" -action: The laser source current set point is decremented by 0.9 mA (0.3 mA * 3).

"LAS:STEP 0.3; LAS:DEC 3, 5000" -action: The laser source current set point is decremented by 0.3 mA, three times, with 5 seconds between decremental steps. So the Laser output is decremented a total of 0.9 mA after 10 seconds.

- Front Panel
- Remote

LASer:ENABLE:

The LASer:ENABLE: command path is used to get to the selected channel's laser status enable commands and queries.

The following commands may be reached directly from the LASer:ENABLE: command path.

LASer:ENABLE:COND	LASer:ENABLE:EVEnt?
LASer:ENABLE:COND?	LASer:ENABLE:OUTOFF
LASer:ENABLE:EVEnt	LASer:ENABLE:OUTOFF?

- Front Panel
- Remote

LASer:ENABLE:COND

The LASer:ENABLE:COND command sets the selected channel's Laser Condition Status Enable register. The bits in this register determine which bits in the Condition Status register are summarized in the 3916 status byte.

SYNTAX DIAGRAM

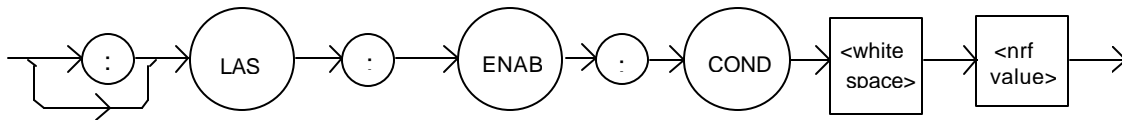

PARAMETERS An <nrf value> whose sum represents the enabled bits:

1 - Laser Current Limit	256 - Output is Off
2 - Laser Voltage Limit	512 - Output In Tolerance
4 - N/A	1024 - Output is On
8 - Power Limit	2048 - N/A
16 - Interlock Disabled	4096 - N/A
32 - N/A	8192 - N/A
64 - N/A	16384 - N/A
128 - Open Circuit	32768 - N/A

POINTS OF INTEREST

This register can be read using the LASer:ENABLE:COND? query.

EXAMPLES

"LAS:ENAB:COND 129" -action: only the Open Circuit and Current Limit conditions will be summarized in the status byte.

Front Panel

LASer:ENABLE:COND?

Remote

The LASer:ENABLE:COND? query returns the value of the selected channel's Laser Condition Status Enable register.

SYNTAX DIAGRAM

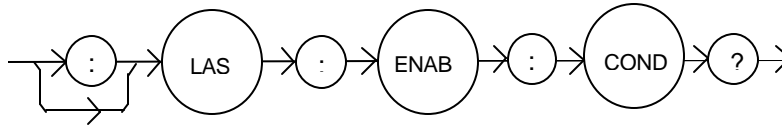

PARAMETERS None. The response is the sum of the following:

1 - Laser Current Limit	256 - Output is Off
2 - Laser Voltage Limit	512 - Output In Tolerance
4 - N/A	1024 - Output Is On
8 - Power Limit	2048 - N/A
16 - Interlock Disabled	4096 - N/A
32 - N/A	8192 - N/A
64 - N/A	16384 - N/A
128 - Open Circuit	32768 - N/A

POINTS OF INTEREST

The selected channel's enabled Laser conditions can be set by using the LASer:ENABLE:COND command.

The Laser condition status can be monitored by the LASer:COND? query.

EXAMPLES

"LAS:ENAB:COND?" -response: 17, means that the Current Limit and Interlock Disabled Laser conditions will be summarized in the status byte.

The LASer:ENABle:EVEnt command sets the selected channel's Laser Event Status Enable register. The bits in this register determine which bits in the Event Status register are summarized in the 3916 Status Byte.

SYNTAX DIAGRAM

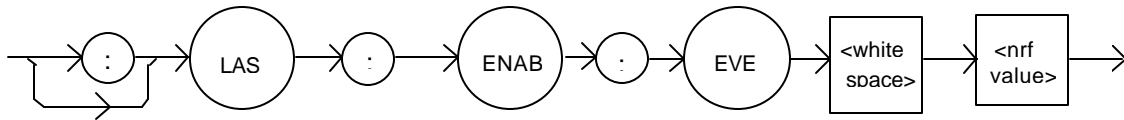

PARAMETERS An <nrf value> whose sum represents the bits which are enabled:

1 - Laser Current Limit Changed State	256 - Output is Off Changed State
2 - Laser Voltage Limit Changed State	512 - Output Changed Tolerance State
4 - N/A	1024 - Output is On Changed State
8 - Power Limit Changed State	2048 - N/A
16 - Interlock Changed State	4096 - N/A
32 - N/A	8192 - N/A
64 - N/A	16384 - N/A
128 - Open Circuit Changed State	32768 - N/A

POINTS OF INTEREST

The enabled Laser events for the selected channel can be read by using the LASer:ENABle:EVEnt? query. The selected channel's Laser event status can be monitored by the LASer:EVEnt? query.

EXAMPLES

"LAS:ENAB:EVENT 136" -action: only the Open Circuit and Power Limit events will be summarized in the status byte.

- Front Panel
- Remote

LASer:ENABle:EVEnt?

The LASer:ENABle:EVEnt? query returns the value of the selected channel's Laser Event Status Enable register.

SYNTAX DIAGRAM

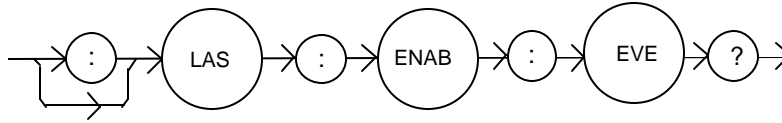

PARAMETERS None. The response is the sum of the following:

1 - Laser Current Limit Changed State	256 - Output is Off Changed State
2 - Laser Voltage Limit Changed State	512 - Output Changed Tolerance State
4 - N/A	1024 - Output Is On Changed State
8 - Power Limit Changed State	2048 - N/A
16 - Interlock Changed State	4096 - N/A
32 - N/A	8192 - N/A
64 - N/A	16384 - N/A
128 - Open Circuit Changed State	32768 - N/A

POINTS OF INTEREST

The enabled Laser events for the selected channel can be set by using the LASer:ENABle:EVEnt command. The selected channel's Laser event status can be monitored by the LASer:EVEnt? query.

EXAMPLES

"LAS:ENAB:EVE?" -response: 1040, means that the Output On Changed State and Interlock Changed State Laser events for the selected channel will be reported (in summarized form) to the status byte.

The LASer:ENABle:OUTOFF command sets the selected channel's Laser Output Off Enable register. The bits in this register determine which conditions will cause the laser output to be automatically disabled.

SYNTAX DIAGRAM

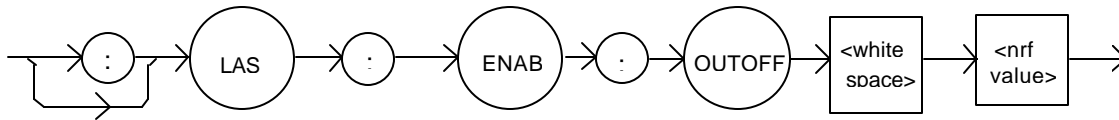

PARAMETERS An <nrf value> whose sum represents the enabled bits:

1 - Laser Current Limit	256 - N/A
2 - Laser Voltage Limit	512 – Output Out of Tolerance
4 - N/A	1024 - TEC Output is Off
8 - Power Limit (With Output On)	2048 - TEC High Temp. Limit
16 - N/A	4096 - N/A
32 - N/A	8192 - N/A
64 - N/A	16384 - N/A
128 - N/A	32768 - N/A

POINTS OF INTEREST

The enabled Laser outoff bits for the selected channel can be read by using the LASer:ENABle:OUTOFF? query.

The default value for this register is 2056: TEC Temperature Limit, and Power Limit.

Enabling voltage limit will cause the Laser output to shut off when the voltage limit is detected, otherwise this voltage limit is a warning. The hardware will shut off (regardless of how the Laser voltage limit bit is set here) when the VLIM voltage is reached.

EXAMPLES

"LAS:ENAB:OUTOFF 2049" -action: the TEC temperature Limit and Laser current limit conditions will cause the Laser output to be turned off.

- Front Panel
- Remote

LASer:ENABLE:OUTOFF?

The LASer:ENABLE:OUTOFF? query returns the contents of the selected channel's Laser Output Off Enable register.

SYNTAX DIAGRAM

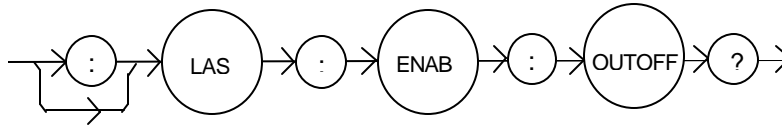

PARAMETERS None. The response is the sum of the following:

1 - Laser Current Limit	256 - N/A
2 - Laser Voltage Limit	512 – Output Out of Tolerance
4 - N/A	1024 - TEC Output is Off Event
8 - Power Limit (With Output On)	2048 - TEC High Temp. Limit Condition
16 - N/A	4096 - N/A
32 - N/A	8192 - N/A
64 - N/A	16384 - N/A
128 - N/A	32768 - N/A

POINTS OF INTEREST

The selected channel's enabled Laser events can be set by using the LASer:ENABLE:OUTOFF command. The selected channel's Laser output status can be monitored by the LASer:EVENT? query.

EXAMPLES

"LAS:ENAB:OUTOFF?" -response: 1025, means that the selected channel's Current Limit condition and a TEC Output off condition will cause the selected channel's Laser output to be turned off.

- Front Panel
- Remote

LASer:EVEnt?

The LASer:EVEnt? query returns the value of the selected channel's Event Status Register.

SYNTAX DIAGRAM

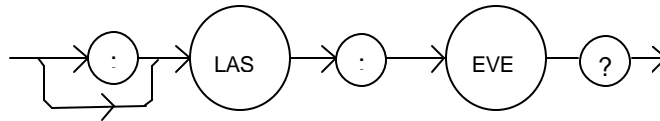

PARAMETERS None. The response is the sum of the following:

- | | |
|---------------------------------------|--------------------------------------|
| 1 - Laser Current Limit Changed State | 256 - Output Is Off Changed State |
| 2 - Laser Voltage Limit Changed State | 512 - Output Changed Tolerance State |
| 4 - N/A | 1024 - Output Is On Changed State |
| 8 - Power Limit Changed State | 2048 - N/A |
| 16 - Interlock Changed State | 4096 - N/A |
| 32 - N/A | 8192 - N/A |
| 64 - N/A | 16384 - N/A |
| 128 - Open Circuit Changed State | 32768 - N/A |

POINTS OF INTEREST

The events that are reported in the status byte can be set by using the LASer:ENABLE:EVEnt command.

The event status is only cleared when the event status is read or by the *CLS command. The condition status, however, is constantly changing.

EXAMPLES

"LAS:EVE?" -response: 9, the Power Limit and Current Limit conditions have changed state since the event register was last read.

The LASer:INC command increments the selected channel's laser constant-current set point by one or more steps. Parameters allow multiple steps to be incremented and the time (in milliseconds) between increments to be set, respectively.

SYNTAX DIAGRAM

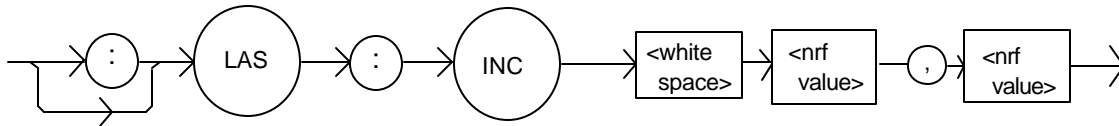

PARAMETERS Two <nrf values> are required. The first represents the number of steps, and the second is the time in milliseconds between steps.

POINTS OF INTEREST The step size can be edited via the LAS:STEP command. Its default value is 1.0 mA.

The first parameter (number of steps) must be an integer between 1 and 50000.

The minimum time to complete one increment is about 10 to 20 msec. Therefore, values for the second parameter (time between increments) have a practical minimum of 20. The maximum number of msec is 65535.

EXAMPLES "LAS:STEP 0.3; LAS:INC 1,10" -action: The selected channel's laser source current set point is incremented by 0.3 mA.

"LAS:OUT on; LAS:STEP 0.3; LAS:INC 3,5000" -action: The set point is incremented by 0.3 mA, three times, with 5 seconds between incremental steps (with the output on); the selected channel's Laser output is incremented a total of 0.9 mA after 10 seconds.

- Front Panel
- Remote

LASer:LDI

The LASer:LDI command sets the laser current setpoint for the selected channel.

SYNTAX DIAGRAM

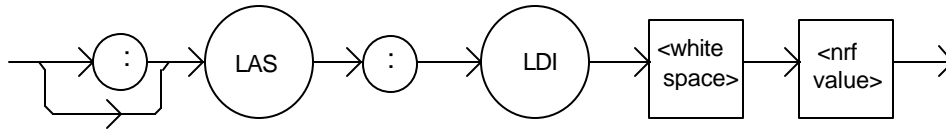

PARAMETERS An <nrf value> which represents the (laser) output current, in mA.

POINTS OF INTEREST The setpoint is the same for both low and high bandwidth output modes.

EXAMPLES "Las:LDI 400" -action: sets the selected channel's laser output current to 400.00 mA.

- Front Panel
- Remote

LASer:LDI?

The LASer:LDI? query returns the value of the measured laser current for the selected channel.

SYNTAX DIAGRAM

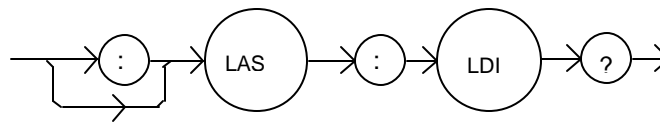

PARAMETERS None. The response is an <nrf value>.

POINTS OF INTEREST Response is the selected channel's measured laser output current, regardless of LAS control mode.

This measurement is updated approximately once every 600 msec.

EXAMPLES "LAS:ldi?" -response: 30.0, means the selected channel's measured laser output current is 30.0 mA.

"Laser:LDI?" -response: 149.6, means the selected channel's measured laser output current is 149.6 mA.

- Front Panel
- Remote

LASer:LDV?

The LASer:LDV? query returns the value of the selected channel's measured laser voltage.

SYNTAX DIAGRAM

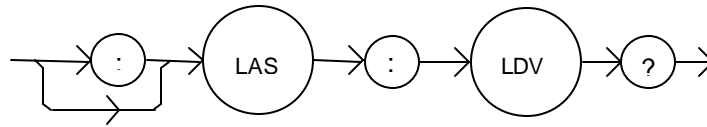

PARAMETERS None. The response is an <nrf value>.

POINTS OF INTEREST Response is the selected channel's measured laser output voltage, regardless of LAS control mode.

This measurement is updated approximately once every 600 msec.

EXAMPLES "LAS:ldv?" -response: 3.03, means the measured laser output voltage is 3.03 volts.

"Laser:LDV?" -response: 1.0, means the measured laser output voltage is 1.00 volts.

- Front Panel
- Remote

LASer:LIMit:

The LASer:LIMit: command path is used to get to the selected channel's laser limit commands.

The following commands may be reached directly from the LASer:LIMit: command path.

LASer:LIMit:I	LASer:LIMit:MDP	LASer:LIMit:V
LASer:LIMit:I?	LASer:LIMit:MDP?	LASer:LIMit:V?

- Front Panel
- Remote

LASer:LIMit:I

The LASer:LIMit:I command sets the selected channel's Laser current limit value.

SYNTAX DIAGRAM

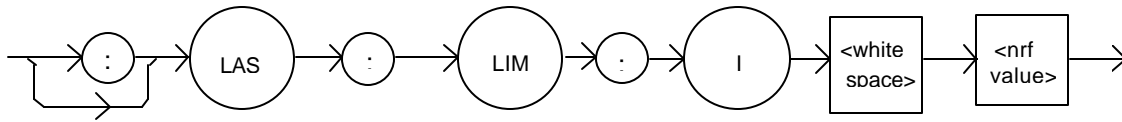

PARAMETERS An <nrf value> which represents the selected channel's Laser limit current, in mA.

POINTS OF INTEREST The current limit is in effect in all modes of operation of the selected channel's laser output.

EXAMPLES "LAS:LIM:I 80" -action: the selected channel's Laser current limit is set to 80 mA.

":Laser:Limit:I 160" -action: the selected channel's Laser current limit is set to 160 mA.

- Front Panel
- Remote

LASer:LIMit:I?

The LASer:LIMit:I? query returns the value of the selected channel's Laser current limit.

SYNTAX DIAGRAM

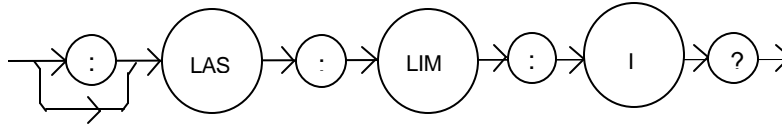

PARAMETERS None. The response is an <nrf value>.

POINTS OF INTEREST The selected channel's current limit is valid for all modes of Laser operation.

EXAMPLES "LAS:LIM:I?" -response: 40, means the selected channel's laser current limit is 40 mA.
 "Laser:LIM:I?" -response: 300, means the selected channel's laser current limit is 300 mA.

- Front Panel
- Remote

LASer:LIMit:V

The LASer:LIMit:V command sets the selected channel's Laser compliance voltage limit value.

SYNTAX DIAGRAM

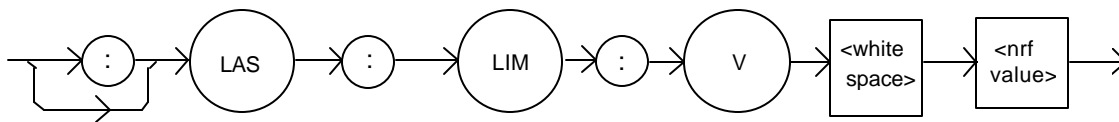

PARAMETERS An <nrf value> which represents the selected channel's Laser limit voltage, in volts.

POINTS OF INTEREST The compliance voltage limit is in effect in all modes of operation of the selected channel's laser output.

The range for the compliance voltage limit is 0.1 to 10.0 volts.

EXAMPLES "LAS:LIM:V 4.6" -action: the selected channel's Laser compliance voltage limit is set to 4.6 volts.

"Laser:Limit:v 6.1" -action: the selected channel's Laser compliance voltage limit is set to 6.1 volts.

- Front Panel
- Remote

LASer:LIMit:V?

The LASer:LIMit:V? query returns the value of the selected channel's Laser compliance voltage limit.

SYNTAX DIAGRAM

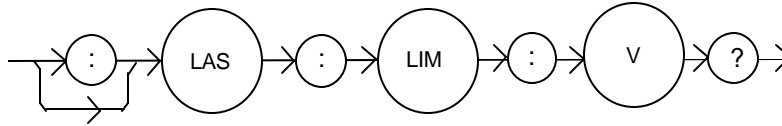

PARAMETERS None. The response is an <nrf value>.

POINTS OF INTEREST The selected channel's compliance voltage limit is valid for all modes of Laser operation.

EXAMPLES "LAS:LIM:V?" -response: 4.0, means the selected channel's laser current limit is 4.0 volts.
 "Laser:LIM:v?" -response: 3.3, means the selected channel's laser current limit is 3.3 volts.

- Front Panel
- Remote

LASer:LIMit:MDP

The LASer:LIMit:MDP command sets the laser monitor photodiode power limit value.

SYNTAX DIAGRAM

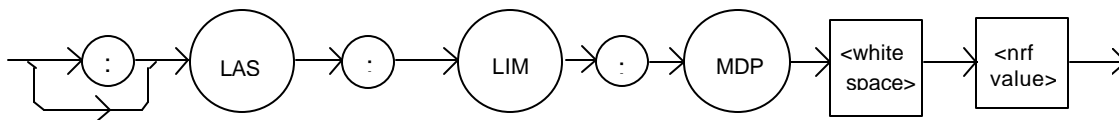

PARAMETERS An <nrf value> which represents the selected channel's laser monitor photodiode power limit, in mW.

POINTS OF INTEREST When constant MDP mode is used, the selected channel's output is limited (in hardware) only by the LIM I value.

The LIM MDP condition normally shuts the selected channel's Laser output off, but this can be disabled via the LASer:ENABLE:OUTOFF command, bit 3.

EXAMPLES "LAS:LIM:MDP 10" -action: sets the selected channel's laser output power limit to a value which corresponds to producing 10.00 mW of PD feedback (optical) power.

"Las:Limit:MDp 5" -action: sets the selected channel's laser output power limit to a value which corresponds to producing 5.00 mW of PD feedback (optical) power.

- Front Panel
- Remote

LASer:LIMit:MDP?

The LASer:LIMit:MDP? query returns the value of the selected channel's laser monitor PD power limit.

SYNTAX DIAGRAM

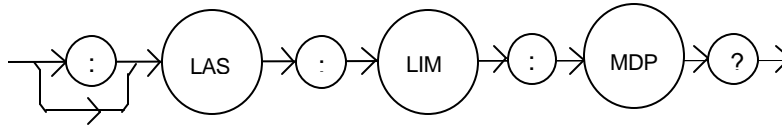

PARAMETERS None. The response is an <nrf value>.

POINTS OF INTEREST The LAS:LIM:MDP is in effect for all LAS operating modes.

EXAMPLES "LAS:LIM:MDP?" -response: 3.0, means the selected channel's monitor PD power limit is set to 3.0 mW.

"LAS:Limit:MDP?" -response: 10.0, means the selected channel's monitor PD power limit is set to 10.0 mW.

- Front Panel
- Remote

LASer:MDI

The LASer:MDI command sets the value of the photodiode feedback current set point, in μA .

SYNTAX DIAGRAM

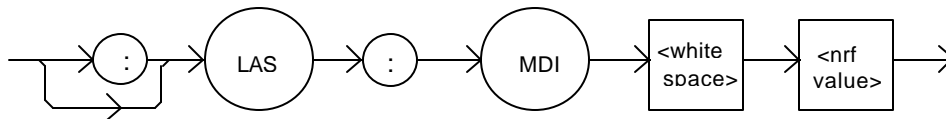

PARAMETERS An <nrf value> which represents the selected channel's photodiode feedback current, in μA .

POINTS OF INTEREST On the front panel, monitor diode current is referred to as IPD.

EXAMPLES "Las:Mdi 40" -action: The selected channel's Laser output is controlled so that the photodiode feedback current remains constant at 40 μA .

"Laser:MDI 200" -action: The selected channel's Laser output is controlled so that the photodiode feedback current remains constant at 200 μA .

- Front Panel
- Remote

LASer:MDI?

The LASer:MDI? query returns the value of the selected channel's laser photodetector current measurement, in μA .

SYNTAX DIAGRAM

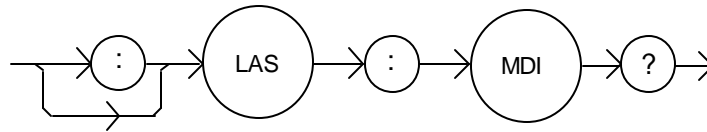

PARAMETERS None. The response is an <nrf value>.

POINTS OF INTEREST The response is in μA . The response is valid, even when the unit is not in MDI mode.

This measurement is updated approximately once every 600 msec.

EXAMPLES "Las:MDi?" -response: 100.0, means 100 μA of photodetector current (from the selected channel) was measured.

- Front Panel
- Remote

LASer:MDP

The LASer:MDP command sets the value of the optical power set point, in mW.

SYNTAX DIAGRAM

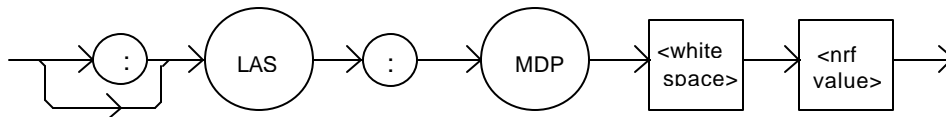

PARAMETERS An <nrf value> which represents the selected channel's photodiode feedback power, in mW.

POINTS OF INTEREST If the selected channel's mode is not MDP, the LAS:MDP value will not be used.

If CALPD is 0, the measured MDP will be invalid, and the actual MDP set point would be (near) 0.

On the front panel, the monitor diode photodetector power is referred to as P.

EXAMPLES "Las:Mdp 40" -action: The selected channel's Laser output is controlled so that the photodiode feedback power remains constant at 40 mW.

- Front Panel
- Remote

LASer:MDP?

The LASer:MDP? query returns the value of the selected channel's laser photodetector power measurement, in mW.

SYNTAX DIAGRAM

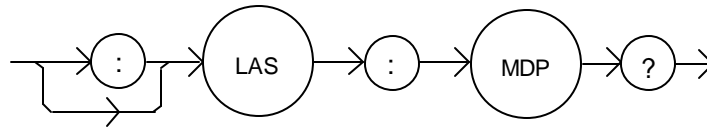

PARAMETERS None. The response is an <nrf value>.

POINTS OF INTEREST The response is in mW. The response is valid, even when the unit is not in constant P mode.

This measurement is updated approximately once every 600 msec.

EXAMPLES Las:MDp?" -response: 100.0: 100 mW of photodetector power was measured on the selected channel.

- Front Panel
- Remote

LASer:MODE?

The LASer:MODE? query returns the present channel's selected laser control mode.

SYNTAX DIAGRAM

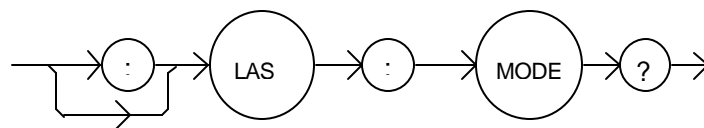

PARAMETERS None. The response is character data (which represents the LAS operating mode).

POINTS OF INTEREST IHBW mode is the same as ILBW mode (low bandwidth), except that the output low bandpass filter is disabled in IHBW mode.

EXAMPLES "LAS:MODE?" -response: ILBW, means that constant I (low bandwidth current) mode is in effect for the selected channel's laser output.

":Las:Mode?" -response: MDP, means that constant P (power) mode is in effect for the selected channel's laser output.

"Las:Mode?" -response: MDI, means that constant monitor current mode is in effect for the selected channel's laser output.

"Laser:MODE?" -response: IHBW, means that IHBW (constant current, high bandwidth) mode is in effect for the selected channel's laser output.

- Front Panel
- Remote

LASer:MODE:

The LASer:MODE: command path is used to get to the selected channel's laser mode selection commands.

The following commands may be reached directly from the LASer:MODE: command path.

LASer:MODE:IHBW
 LASer:MODE:ILBW
 LASer:MODE:MDI
 LASer:MODE:MDP

- Front Panel
- Remote

LASer:MODE:IHBW

The LASer:MODE:IHBW command selects laser high bandwidth constant current mode for the selected channel.

SYNTAX DIAGRAM

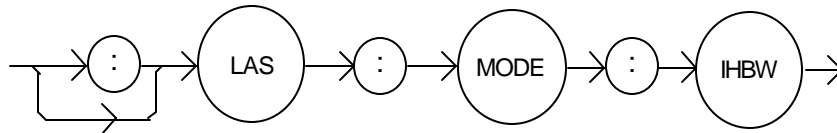

PARAMETERS

None.

POINTS OF INTEREST

In high bandwidth mode the modulation bandwidth is increased.

EXAMPLES

":las:mode:ihbw" -action: enables the laser high bandwidth constant current mode for the selected channel.

"LAS:Mode:Ihbw" -action: enables the laser high bandwidth constant current mode for the selected channel.

- Front Panel
- Remote

LASer:MODE:ILBW

The LASer:MODE:ILBW command selects laser constant current mode.

SYNTAX DIAGRAM

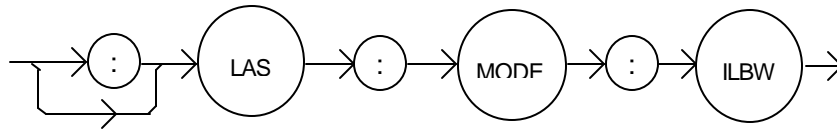

PARAMETERS None.

POINTS OF INTEREST Constant ILBW mode (low bandwidth) enables the selected channel's output low bandpass filter.

EXAMPLES "LAS:MODE:ILBW" -action: sets the selected channel's laser output for constant I mode (low bandwidth).

- Front Panel
- Remote

LASer:MODE:MDI

The LASer:MODE:MDI command selects laser constant monitor diode current mode for the present channel.

SYNTAX DIAGRAM

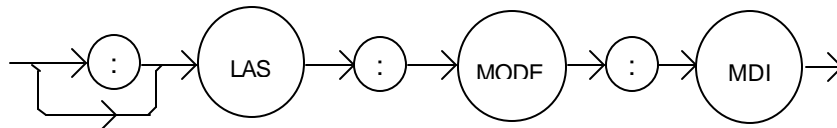

PARAMETERS None.

POINTS OF INTEREST On the front panel, monitor diode current mode is referred to as IPD mode.

In this mode, the control set point is entered via the LAS:MDI command.

EXAMPLES "Laser:Mode:MDi" -action: sets the selected channel's laser output mode of operation to constant monitor diode current mode.

- Front Panel
- Remote

LASer:MODE:MDP

The LASer:MODE:MDP command selects constant optical power mode for the present channel.

SYNTAX DIAGRAM

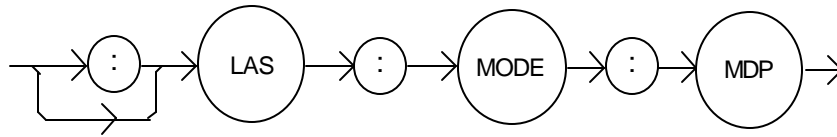

PARAMETERS None.

POINTS OF INTEREST

On the front panel, photodetector power mode is referred to as P mode.

This mode of laser operation uses the monitor photodiode feedback current to maintain constant optical power. The actual set point will be a monitor current value calculated via the CALPD conversion factor. Therefore, in this mode the set point is only as accurate as the user's CALPD value.

EXAMPLES "LAS:MODE:MDP" -action: sets the selected channel's laser output mode of operation to constant optical power mode.

- Front Panel
- Remote

LASer:MODulation

The LASer:MODulation command turns the selected channel's laser modulation switch on or off.

SYNTAX DIAGRAM

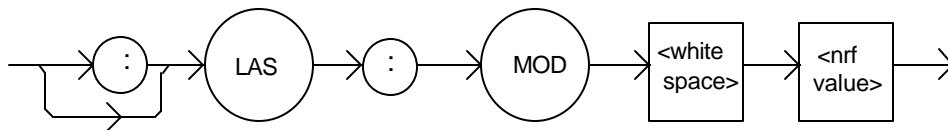

PARAMETERS An <nrf value>; 1 = on, 0 = off.

POINTS OF INTEREST

When the modulation switch is enabled for a channel, the laser current may be modulated by connecting a modulation signal onto the 3916's back panel "MODULATION" connector.

The modulation bandwidth depends on the LAS operating mode and module used. Refer to Chapter 1, Laser Specifications, for more information on bandwidth specifications.

EXAMPLES "LAS:LDI 20; LAS:MODULA ON" -action: sets the selected channel's laser output current to 20 mA and then turns the selected channel's modulation switch on.

"Las:Mod 0" -action: turns the selected channel's modulation switch off.

- Front Panel
- Remote

LASer:MODulation?

The LASer:MODulation? query returns the status of the selected laser channel's modulation switch.

SYNTAX DIAGRAM

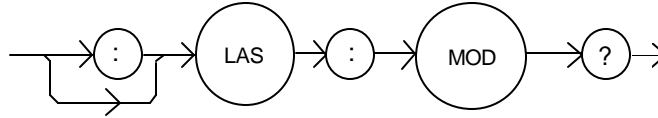

PARAMETERS None. The response is an <nrf value>, 1 = ON, 0 = OFF.

POINTS OF INTEREST More than one channel at a time may be modulated via the modulation signal, if desired.

EXAMPLES "Las:MODULATION?" -response: 0, means that the selected channel's modulation switch is disabled.

"LAS:MOD?" -response: 1, means that the selected channel's modulation switch is enabled. A modulating signal applied to the back panel connector will be present at the selected channel.

- Front Panel
- Remote

LASer:OUTput

The LASer:OUTput command turns the selected channel's laser output on or off.

SYNTAX DIAGRAM

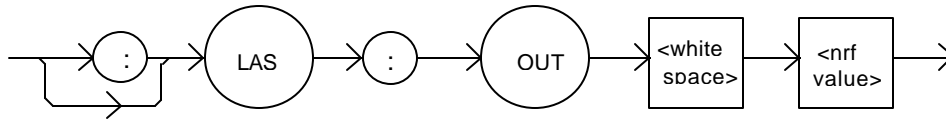

PARAMETERS An <nrf value>; 1 = on, 0 = off.

POINTS OF INTEREST

After the selected channel's output is turned on, it may be useful to wait until the output is fully on before performing further operations, but it is not necessary. When the LAS output is turned on, there is a two second delay before the LAS output is actually enabled. This is a safety requirement.

When a Laser output is off, an internal short is placed across the output terminals.

EXAMPLES

"LAS:LDI 20; LAS:OUT ON" -action: sets the selected channel's laser output current to 20 mA and then turns the selected channel's output on.

"Las:Out 0" -action: turns the selected channel's laser output off.

- Front Panel
- Remote

LASer:OUTput?

The LASer:OUTput? query returns the status of the selected channel's laser OUTPUT switch.

SYNTAX DIAGRAM

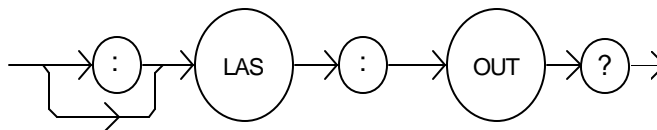

PARAMETERS None. The response is an <nrf value>.

POINTS OF INTEREST

Although the status of the switch is on, the selected channel's output may not have reached the set point value.

EXAMPLES

"Las:OUT?" -response: 0, means that the selected channel's OUTPUT switch is disabled; devices may be safely disconnected or connected at the selected channel's output terminals.

"LAS:OUT?" -response: 1, means that the selected channel's OUTPUT switch is enabled, Laser output current is present for the selected channel.

- Front Panel
- Remote

LASer:SET:

The LASer:SET: command path is used to get to the selected channel's laser set point queries.

The following commands may be reached directly from the LASer:SET: command path.

LASer:SET:LDI?
 LASer:SET:MDI?
 LASer:SET:MDP?

- Front Panel
- Remote

LASer:SET:LDI?

The LASer:SET:LDI? query returns the constant current setpoint which is used for both bandwidth modes.

SYNTAX DIAGRAM

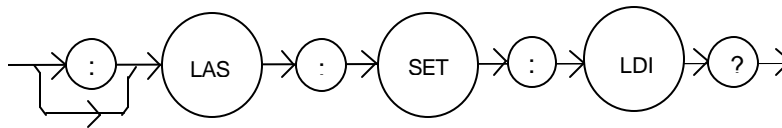

PARAMETERS None. The response is an <nrf value> which represents the selected channel's constant I set point value, in mA.

POINTS OF INTEREST The LDI set point is only in effect when the LAS operating mode is IHBW or ILBW.

EXAMPLES "LAS:SET:LDI?" -response: 50.0, means the selected channel's laser output current set point value is 50.0 mA.

- Front Panel
- Remote

LASer:SET:MDI?

The LASer:SET:MDI? query returns the selected channel's laser monitor photodiode current set point value, in μA .

SYNTAX DIAGRAM

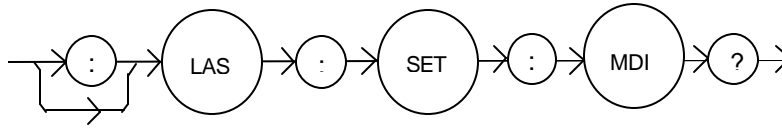

PARAMETERS None. The response is an <nrf value> which represents the selected channel's constant IPD set point value, in μA .

POINTS OF INTEREST The monitor photodiode current is directly proportional to the laser optical output power. Therefore, the IPD setpoint may be used to control optical output of the laser.

EXAMPLES "las:set:mdi?" -response: 30.0, means the selected channel's laser monitor PD current setpoint is 30 μA , for use in constant MDI mode.

- Front Panel
- Remote

LASer:SET:MDP?

The LASer:SET:MDP? query returns the selected channel's laser optical power set point value, in mW.

SYNTAX DIAGRAM

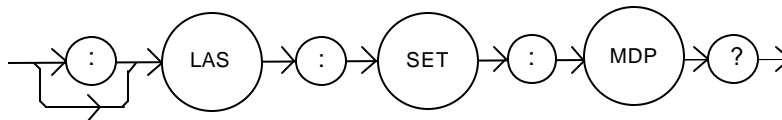

PARAMETERS None. The response is an <nrf value> which represents the selected channel's constant P set point, in mW.

POINTS OF INTEREST This set point is used in constant MDP (P) mode only.

EXAMPLES "LAS:Set:MDP?" -response: 10.0, means the selected channel's laser monitor PD feedback set point is 10.0 mW (CALPD > 0).

- Front Panel
- Remote

LASer:STEP

The LASer:STEP command specifies the amount the current setpoint will change in response to the LASer:INC or LASer:DEC command.

SYNTAX DIAGRAM

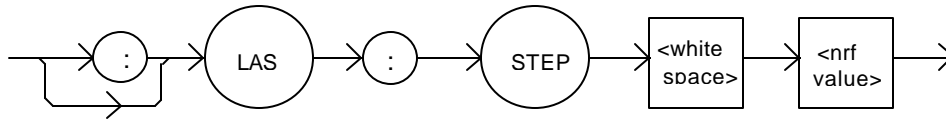

PARAMETERS An <nrf value> of the step amount, in the range 1.0 to 100.0. The resolution is 0.1.

POINTS OF INTEREST The step of 0.1 corresponds to 0.1 mA.

EXAMPLES "Las:ldi 20; Las:Step 10.0; Las:Inc 1,1; Las:set:i?" -action: sets the selected channel's step to 10.0 mA, so the Las:set:i? query will return a value of 30.0 mA.

"LAS:STEP 10" -action: sets the selected channel's step size to 10.00 mA.

- Front Panel
- Remote

LASer:STEP?

The LASer:STEP? query is used to read back the selected channel's STEP value. This value, in mA, is used by the Las:Inc and Las:Dec commands to increment or decrement the laser current setpoint.

SYNTAX DIAGRAM

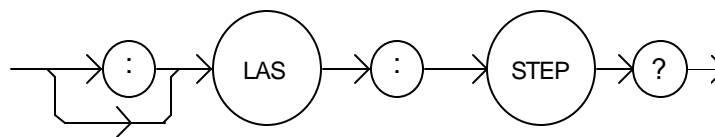

PARAMETERS None. The response is an <nrf value> of the selected channel's step amount.

POINTS OF INTEREST The step of 1 corresponds to 1.0 mA.

EXAMPLES "Las:Step?" -response: 1.0 means the selected channel's step size is 1.0 mA .

- Front Panel
- Remote

LASer:SYNCLDI?

The LASer:SYNCLDI? query returns the value of the selected channel's measured laser current, in mA.

SYNTAX DIAGRAM

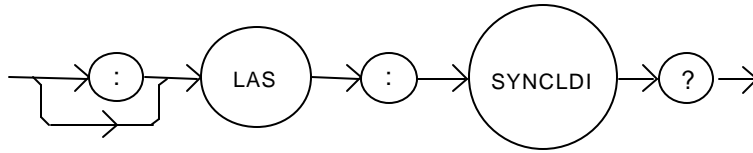

PARAMETERS None. The response is an <nrf value> representing current in mA.

POINTS OF INTEREST

This is a “synchronized” measurement: the measurement system is connected to the current-measure signal when this query is received. A current measurement is made, and the result is returned as the response. After the measurement is made, the measurement system returns to its normal function, switching between the various signals and measuring them.

The response time to this query is from 200 msec to 250 msec, but the measurement is made as soon as the query is received. In contrast, the laser:ldi? query returns immediately, but the measurement can be up to 600 msec old.

EXAMPLES "LAS:syncldi?" -response: 54.1, means the measured laser current is 54.1 mA.

- Front Panel
- Remote

LASer:SYNCLDV?

The LASer:SYNCLDV? query returns the value of the selected channel's measured laser voltage, in volts.

SYNTAX DIAGRAM

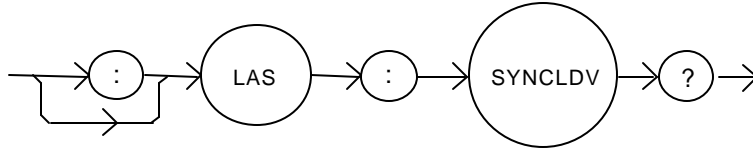

PARAMETERS None. The response is an <nrf value> representing voltage in Volts.

POINTS OF INTEREST

This is a “synchronized” measurement: the measurement system is connected to the voltage-measure signal when this query is received. A voltage measurement is made, and the result is returned as the response. After the measurement is made, the measurement system returns to its normal function, switching between the various signals and measuring them.

The response time to this query is from 200 msec to 250 msec, but the measurement is made as soon as the query is received. In contrast, the laser:ldv? query returns immediately, but the measurement can be up to 600 msec old.

EXAMPLES "LAS:syncldv?" -response: 3.03, means the measured laser output voltage is 3.03 volts.

□ Front Panel

■ Remote

LASer:SYNCMDI?

The LASer:SYNCMDI? query returns the value of the selected channel's measured monitor photodiode current in μA .

SYNTAX DIAGRAM

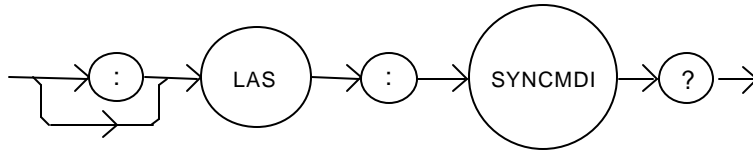

PARAMETERS None. The response is an <nrf value> representing current in μA .

POINTS OF INTEREST

This is a “synchronized” measurement: the measurement system is connected to the monitor current-measure signal when this query is received. The photodiode current measurement is made, and the result is returned as the response. After the measurement is made, the measurement system returns to its normal function, switching between the various signals and measuring them.

The response time to this query is from 200 msec to 250 msec, but the measurement is made as soon as the query is received. In contrast, the laser:mdi? query returns immediately, but the measurement can be up to 600 msec old.

EXAMPLES "LAS:syncmdi?" -response: 145.5, means the measured photodiode current is 145.5 μA .

- Front Panel
- Remote

LASer:SYNCMDP?

The LASer:SYNCMDP? query returns the value of the selected channel's measured optical power, in mW.

SYNTAX DIAGRAM

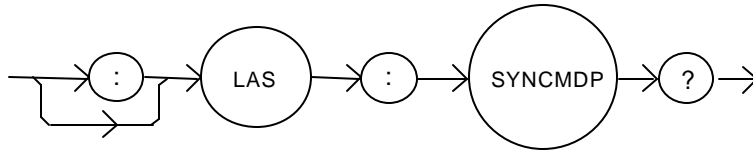

PARAMETERS None. The response is an <nrf value> representing optical power in mW.

POINTS OF INTEREST Optical power is derived from photodiode current. Optical power is defined as photodiode current divided by CalPD, the photodiode responsivity.

This is a “synchronized” measurement: the measurement system is connected to the monitor current-measure signal when this query is received. The photodiode current measurement is made, optical power is calculated, and the result is returned as the response. After the measurement is made, the measurement system returns to its normal function, switching between the various signals and measuring them.

The response time to this query is from 200 msec to 250 msec, but the measurement is made as soon as the query is received. In contrast, the laser:mdp? query returns immediately, but the measurement can be up to 600 msec old.

EXAMPLES "LAS:syncmdp?" -response: 5.5, means the calculated optical power is 5.5 mW.

- Front Panel
- Remote

LAS:TOLerance

The LAS:TOLerance command sets the selected module's laser control tolerance parameters.

SYNTAX DIAGRAM

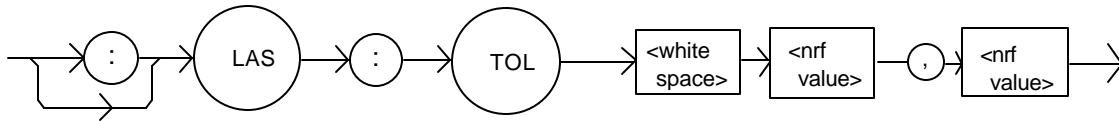

PARAMETERS Two <nrf values>; the first represents the measurement window, in mA, μ A, or mW, depending on the laser control mode. The second parameter represents the time window, in seconds.

POINTS OF INTEREST The range of the first parameter, the tolerance window, is 0.01 to 500.0. The units of this parameter depend on the control mode. In current mode, the units are mA, in IPD mode the units are μ A. If the mode is constant power (P), the first parameter is in mW. The range of the second parameter, the time window, is 0.1 to 50.0.

The LDC-3916370 Series Laser Diode Controller defaults to a tolerance of 100 mA, μ A, or mW, for 5 seconds, unless changed by the LAS:TOLerance command.

WARNING: If the tolerance is set too tight, the output may never reach tolerance.

EXAMPLES "LAS:LDI 750;LAS:TOL 0.5,1;LAS:OUT ON" -action: the laser current will be in tolerance when it is within 0.5 mA of 750.00 mA for a period of 1.0 second, at which point the In Tolerance bit in the Laser Condition Status register will be set.

- Front Panel
- Remote

LAS:TOLerance?

The LAS:TOLerance? query returns the selected module's laser control tolerance parameters.

SYNTAX DIAGRAM

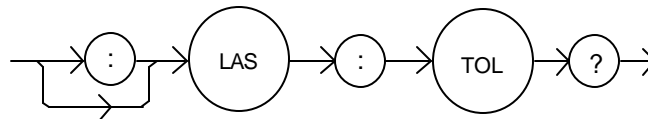

PARAMETERS None. The response is two <nrf values> representing the tolerance parameters. The first represents the tolerance window, in mA, μ A, or mW, (depending on the mode). The second represents the tolerance duration, in seconds.

POINTS OF INTEREST The laser tolerance specification is also used in the laser status event and condition registers, and may be tested by using the appropriate query.

EXAMPLES "LAS:TOL?" -response: "0.2,1.0", means the selected module has a laser tolerance window of 0.2 mA, 0.2 μ A, or 0.2 mW (depending on the mode) with a duration of 1.0 seconds.
 "LAS:TOL?" -response: "1.0,5.0", means the selected module has a laser tolerance window of 1.0 mA, 1.0 μ A, or 1.0 mW (depending on the mode) with a duration of 5.0 seconds.

Front Panel

STATMENU:LINE*n*:

Remote

The STATMENU:LINE*n*: command path is used to get to the selected channel's status menu display selection commands. (*n* can be either 1 or 2).

The following commands may be reached directly from the STATMENU:LINE*n*: command path.

STATMENU:LINE*n*:IPD
STATMENU:LINE*n*:LDI
STATMENU:LINE*n*:PPD
STATMENU:LINE*n*:VF
STATMENU:LINE*n*:TEMP
STATMENU:LINE*n*:ITE
STATMENU:LINE*n*:RES
STATMENU:LINE*n*:TEV

Front Panel

STATMENU:LINE*n*?

Remote

The STATMENU:LINE*n*? query returns name of the measurement that is currently being displayed on line *n* of the status menu. (*n* can be either 1 or 2).

SYNTAX DIAGRAM

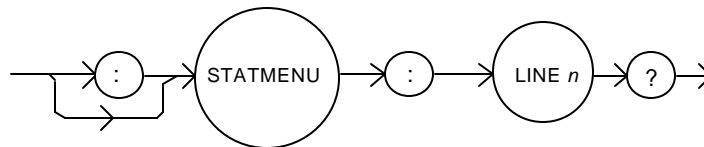

PARAMETERS

None. The response is character data which represents the measurement that is currently being displayed on line 1 of the selected channel's portion of the status menu.

POINTS OF INTEREST

The possible responses are 1: "LDI" laser diode current.
2: "IPD" photodiode current.
3: "PPD" optical power.
4: "VF" laser diode forward voltage.
5: "TEMP" tec temperature
6: "ITE" tec current
7: "RES" thermistor resistance
8: "TEV" tec forward voltage

The default condition of the status menu displays tec temperature (TEMP) on line 1 and laser diode current (LDI) on line 2.

EXAMPLES

"STATMENU:LINE1?" -response: "PPD", means that optical power is selected to be displayed on line 1.

Front Panel

STATMENU:LINE n :IPD

Remote

The STATMENU:LINE n :IPD command sets the measurement that is to be displayed on line n of the status menu to photodiode current (IPD).

SYNTAX DIAGRAM

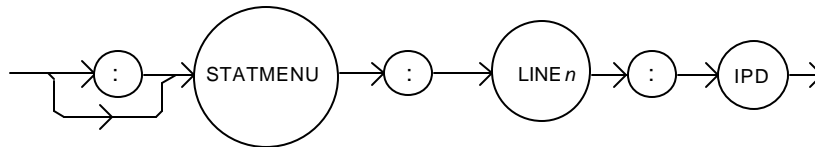

PARAMETERS None.

POINTS OF INTEREST The default condition of the status menu displays tec temperature (TEMP) on line 1 and laser diode current (LDI) on line 2.

EXAMPLES “STATMENU:LINE1:IPD” -response: photodiode current is displayed on line 1 of the status menu.

Front Panel

STATMENU:LINE n :LDI

Remote

The STATMENU:LINE n :LDI command sets the measurement that is to be displayed on line n of the status menu to laser diode current (LDI).

SYNTAX DIAGRAM

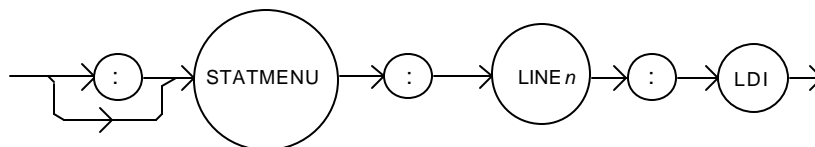

PARAMETERS None.

POINTS OF INTEREST The default condition of the status menu displays tec temperature (TEMP) on line 1 and laser diode current (LDI) on line 2.

EXAMPLES “STATMENU:LINE2:LDI” -response: laser diode current is displayed on line 2 of the status menu.

Front Panel

STATMENU:LINE n :PPD

Remote

The STATMENU:LINE n :PPD command sets the measurement that is to be displayed on line n of the status menu to optical power (PPD).

SYNTAX DIAGRAM

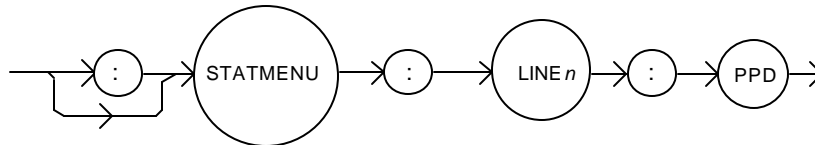

PARAMETERS None.

POINTS OF INTEREST Photodetector power is calculated via the CALPD conversion factor. The measurement is only as accurate as the user's CALPD value.

EXAMPLES "STATMENU:LINE1:PPD" -response: optical power is displayed on line 1 of the status menu.

Front Panel

STATMENU:LINE n :VF

Remote

The STATMENU:LINE n :VF command sets the measurement that is to be displayed on line n of the status menu to laser diode forward voltage (VF).

SYNTAX DIAGRAM

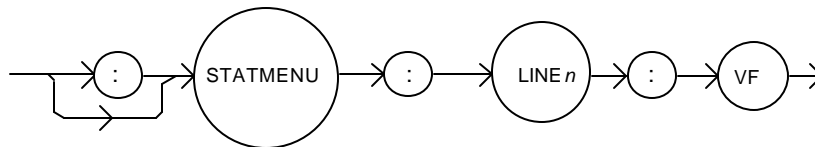

PARAMETERS None.

EXAMPLES "STATMENU:LINE1:VF" -response: laser diode forward voltage is displayed on line 1 of the status menu.

Front Panel

STATMENU:LINE n :TEMP

Remote

The STATMENU:LINE n :TEMP command sets the measurement that is to be displayed on line n of the status menu to tec temperature (TEMP).

SYNTAX DIAGRAM

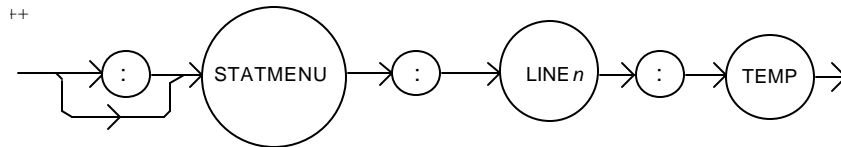

PARAMETERS None.

POINTS OF INTEREST The default condition of the status menu displays tec temperature (TEMP) on line 1 and laser diode current (LDI) on line 2.

EXAMPLES “STATMENU:LINE1:TEMP” -response: tec temperature is displayed on line 1 of the status menu.

Front Panel

STATMENU:LINE n :ITE

Remote

The STATMENU:LINE n :ITE command sets the measurement that is to be displayed on line n of the status menu to tec current (ITE).

SYNTAX DIAGRAM

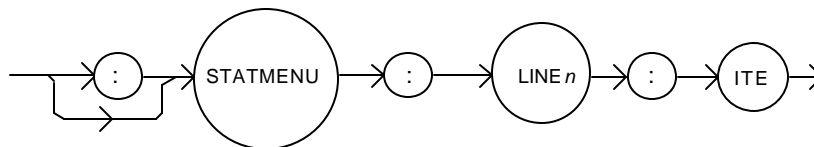

PARAMETERS None.

EXAMPLES “STATMENU:LINE1:ITE” -response: tec current is displayed on line 1 of the status menu.

Front Panel

STATMENU:LINE n :RES

Remote

The STATMENU:LINE n :RES command sets the measurement that is to be displayed on line n of the status menu to thermistor resistance (RES).

SYNTAX DIAGRAM

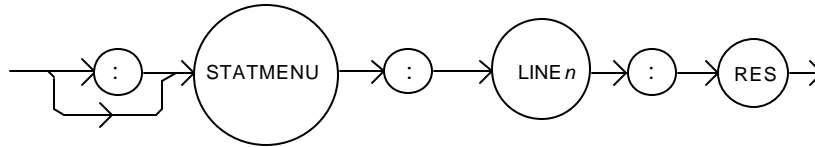

PARAMETERS None.

EXAMPLES "STATMENU:LINE1:RES" -response: thermistor resistance is displayed on line 1 of the status menu.

Front Panel

STATMENU:LINE n :TEV

Remote

The STATMENU:LINE n :TEV command sets the measurement that is to be displayed on line n of the status menu to tec forward voltage (TEV).

SYNTAX DIAGRAM

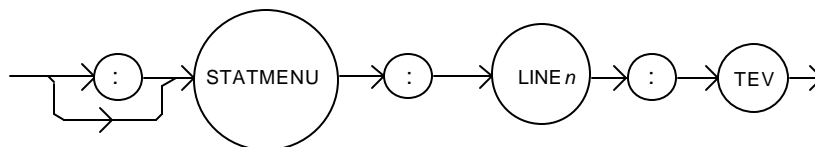

PARAMETERS None.

EXAMPLES "STATMENU:LINE1:TEV" -response: tec forward voltage is displayed on line 1 of the status menu.

- Front Panel
- Remote

MODERR?

The MODERR? query returns a list of “module” device and command errors. The “module” errors are those which have occurred since the last “MODERR?” query. The errors are notated by a number (code) which corresponds to the type of error which occurred. See the appropriate module instruction manual for information regarding error handling for each specific module.

SYNTAX DIAGRAM

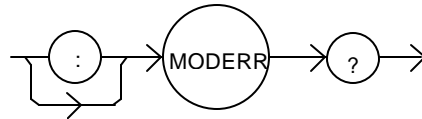

PARAMETERS None. The response consists of one or more “module” error code values, separated by commas.

POINTS OF INTEREST A response of “0” indicates that no errors were reported. The response data is sent as character data.

EXAMPLES "MODERR?" -response: 0 means no “module” errors reported.
"Moderr?" -response: 501, means that the module has a LASER interlock error which prevented the LAS output from being turned on.

- Front Panel
- Remote

MODIDN?

The MODIDN? query returns the module’s model name and serial number.

SYNTAX DIAGRAM

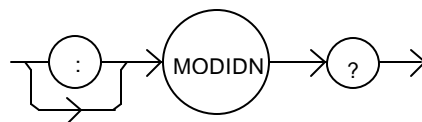

PARAMETERS None. The response consists of the module’s model number, serial number, and version number, separated by commas.

POINTS OF INTEREST The serial number may also be found by removing the module from the mainframe and viewing the serial number information on the side of the module.

EXAMPLES "MODIDN?" -response: “3916374,03740001,v1.00”, for example.

Note: MODERR, MODIDN and MODPUD commands are also described in chapter 4 of the mainframe instruction manual.

- Front Panel
- Remote

MODPUD

The MODPUD command allows the service technician to enter the protected user data. This data is normally changed only at the factory, and therefore the MODPUD command is not needed by the user.

- Front Panel
- Remote

MODPUD?

The MODPUD? query returns protected user data from a module. This data is entered by factory personnel when the module is calibrated.

SYNTAX DIAGRAM

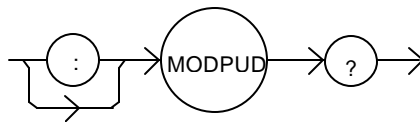

PARAMETERS None. The response consists of serial number, hardware version, option information, calibration date, and initials of the calibrating technician. The response is in the form of <arbitrary block data> with the header, #221, indicating twenty-one characters.

POINTS OF INTEREST The serial number may also be found by removing the module from the mainframe and viewing the serial number information on the side of the module.

EXAMPLES "MODPUD?" -response: #221037200020011120498grb

Note: MODERR, MODIDN and MODPUD commands are also described in chapter 4 of the mainframe instruction manual.

- Front Panel
- Remote

TEC:

The TEC: command path is used to get to the LDC-3916370 Series thermoelectric cooler (TEC) source commands.

The following command paths may be reached from the TEC: command path.

TEC:CAL:	TEC:CONV:R
TEC:ENABle:	TEC:CONV:R?
TEC:LIMit:	TEC:CONV:T
TEC:MODE:	TEC:CONV:T?
TEC:SET:	

The following commands may be reached directly from the TEC: command path.

TEC:COND?	TEC:MODE?	TEC:T?
TEC:CONST	TEC:OUTput	TEC:TOL
TEC:CONST?	TEC:OUTput?	TEC:TOL?
TEC:EVEnt?	TEC:R	TEC:V?
TEC:GAIN	TEC:R?	TEC:SYNCI?
TEC:GAIN?	TEC:SENsor	TEC:SYNCR?
TEC:ITE	TEC:SENsor?	TEC:SYNCT?
TEC:ITE?	TEC:T	TEC:SYNCV?

- Front Panel
- Remote

TEC:CAL:

The TEC:CAL: command path is used to get to the selected Channel's TEC calibration commands.

The following commands may be reached directly from the TEC:CAL: command path.

```
TEC:CAL:ABORT
TEC:CAL:DEFAULT
TEC:CAL:MEAS
TEC:CAL:ITE
TEC:CAL:SENsor
TEC:CAL:STAT?
TEC:CAL:V
TEC:CAL:VALUE?
```

CAUTION: It should be noted that if at anytime during the calibration procedure the user exits the calibration menu by pressing the **Up-Arr**ow softkey, the **MAIN** key or the **CHAN** key, the calibration procedure will be aborted.

- Front Panel
- Remote

TEC:CAL:ABORT

The TEC:CAL:ABORT command is used to exit a TEC calibration without changing the calibration values.

SYNTAX DIAGRAM

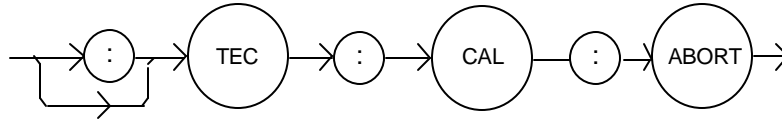

PARAMETERS None.

POINTS OF INTEREST

After this command is issued it is safe to run the LDC-3916370 Series Laser Diode Controller with the same calibration values used as before the TEC calibration mode was started.

This command is intended for use after a false or invalid calibration value is entered, or to exit calibration mode before any values have been entered.

EXAMPLES "TEC:CAL:ABORT" -action: the LDC-3916370 Series Laser Diode Controller exits calibration mode.

- Front Panel
- Remote

TEC:CAL:DEFAULT

The TEC:CAL:DEFAULT command is used to restore all of the module's TEC calibration default values. This command should be used with caution, as the accuracy of the module will not be guaranteed after it is issued.

SYNTAX DIAGRAM

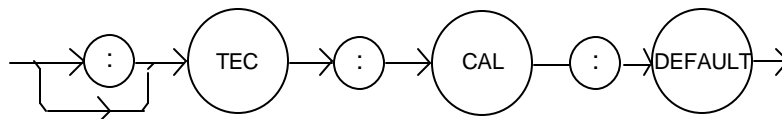

PARAMETERS None.

POINTS OF INTEREST

This command should not be used except when normal calibration procedures and/or normal operation of the TEC functions are not possible.

After this command is issued, the TEC module will not be calibrated. Each of the prescribed calibration procedures must be redone. The default values are the starting point values which exist before factory calibration is done.

EXAMPLES "Tec:CAL:Default" -action: the LDC-3916370 Series Laser Diode Controller sets all of the TEC calibration values to defaults on the selected module.

- Front Panel
- Remote

TEC:CAL:ITE

The TEC:CAL:ITE command initiates the selected channel's calibration procedure for TEC current setpoint, current limit, and current measurement.

SYNTAX DIAGRAM

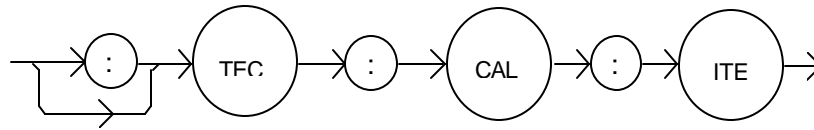

PARAMETERS None.

POINTS OF INTEREST This command puts the module into an automatic calibration mode. It requires the user to enter certain measurements at specified times. This procedure is outlined in Chapter 5 of this manual.

EXAMPLES "Tec:CAL:ITE" -action: the selected Channel enters TEC calibration mode for current.

- Front Panel
- Remote

TEC:CAL:MEAS

The TEC:CAL:MEAS command is used to enter the TEC calibration values for the selected channel.

SYNTAX DIAGRAM

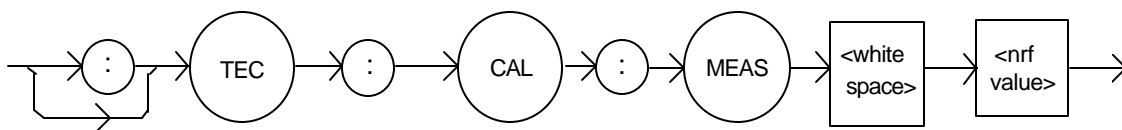

PARAMETERS An <nrf value> which represents the calibration value expected for the present TEC calibration state.

POINTS OF INTEREST The TEC:CAL:STAT? query may be used to determine if the module is ready for the user to enter a value via the TEC:CAL:MEAS command.

EXAMPLES "TEC:CAL:MEAS 4.95" -action: the LDC-3916370 Series Laser Diode Controller enters the value 4.95 for calibration value of the present calibration mode.

- Front Panel
- Remote

TEC:CAL:SENsor

The TEC:CAL:SENsor command initiates the selected channel's thermistor resistance calibration procedure.

SYNTAX DIAGRAM

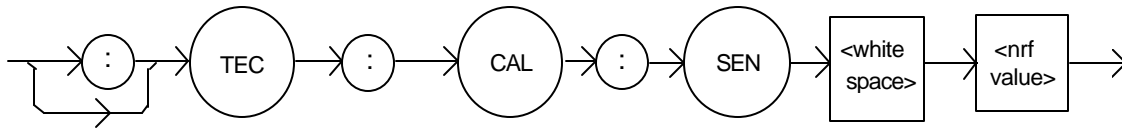

PARAMETERS An <nrf value> which represents the thermistor sense current range, 1 = 100 μ A, 2 = 10 μ A.

POINTS OF INTEREST After this command is issued, the LDC-3916 will automatically enter the sensor calibration mode for the selected channel. This calibration procedure is outlined in Chapter 5 of this manual.

EXAMPLES "Tec:CAL:SEN 1" -action: the selected Channel enters thermistor calibration mode for the 100 μ A thermistor mode.

"Tec:Cal:Sensor 2" -action: the selected channel enters calibration mode for the 10 μ A thermistor mode.

- Front Panel
- Remote

TEC:CAL:STATus?

The TEC:CAL:STATus? query is used to determine whether the selected channel is in calibration mode and whether it is ready for a calibration value.

SYNTAX DIAGRAM

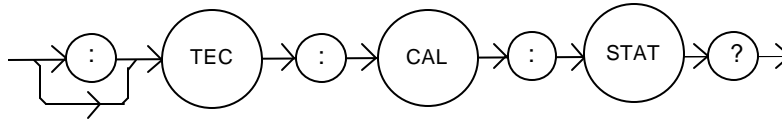

PARAMETERS None. The response will be an <nrf value>; 0 = Not Ready for Measurement, 1 = Ready for Measurement, 2 = Calibration Completed, and 3 = Calibration Aborted.

POINTS OF INTEREST If the calibration is aborted, the status value will remain “3” until the calibration is started again. The calibration procedure may terminate prematurely if, for example, an value entered using the TEC:CAL:MEAS command is invalid. The user can also abort calibration using the TEC:CAL:ABORT command.

EXAMPLES "Tec:Cal:Stat?" -response: 0, means the LDC-3916370 Series Laser Diode Controller module is not yet ready for the TEC calibration measurement value to be entered.

"TEC:CAL:STAT?" -response: 1, means the module is ready for a calibration measurement to be entered via the “TEC:CAL:MEAS” command.

"TEC:CAL:STAT?" -response: 2, means the module has completed the TEC calibration.

- Front Panel
- Remote

TEC:CAL:V

The TEC:CAL:V command initiates the selected channel’s TE voltage measurement calibration procedure.

SYNTAX DIAGRAM

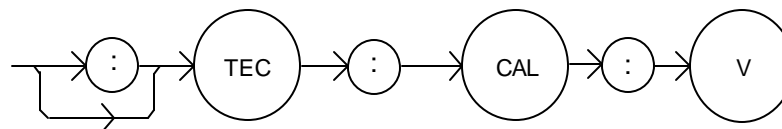

PARAMETERS None.

POINTS OF INTEREST This command places the module in an automatic calibration mode. It requires the user to enter certain measurements at specified times. The required procedure is described in Chapter 5 of this manual.

EXAMPLES "Tec:CAL:V" -action: the LDC-391637X module enters TEC voltage calibration mode.

- Front Panel
- Remote

TEC:CAL:VALUE?

The TEC:CAL:VALUE? query is used at the factory only.

- Front Panel
- Remote

TEC:COND?

The TEC:COND? query returns the value of the selected channel's TEC Condition Status register.

SYNTAX DIAGRAM

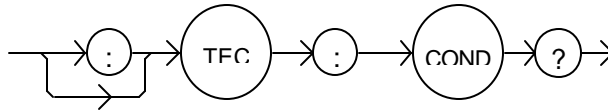

PARAMETERS None. The response is the sum of the following:

1 - TE Current Limit	256 - N/A
2 - TE Voltage Limit	512 - Output In Tolerance
4 - N/A	1024 - Output On
8 - High Temperature Limit	2048 - N/A
16 - N/A	4096 - N/A
32 - N/A	8192 - N/A
64 - Sensor Open	16384 - N/A
128 - TE Module Open	32768 - N/A

POINTS OF INTEREST

The TEC conditions that are reported to the 3916 Status Byte can be set using the TEC:ENABle:COND command. See Chapter 3 of this manual and the Status Reporting section the 3916 manual for more information.

The conditions that are reflected in the Condition Status register are, in general, transitory. To ensure that a control program does not miss the occurrence of a condition, use the TEC:EVEnt? query.

EXAMPLES "TEC:COND?" -response: 513, means that the TE Output In Tolerance and TE Current Limit conditions currently exist.

- Front Panel
- Remote

TEC:CONST

The TEC:CONST command sets the selected channel's Steinhart-Hart equation constants.

SYNTAX DIAGRAM

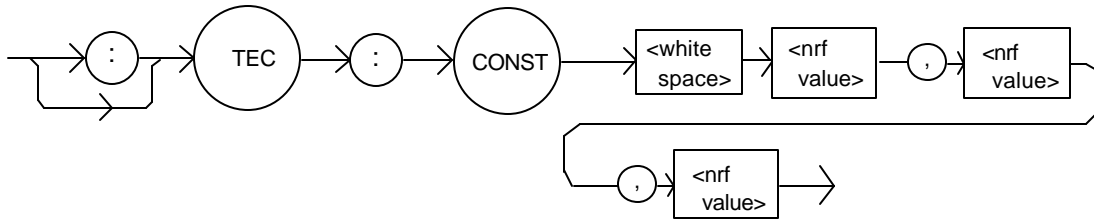

PARAMETERS Three <nrf value>s, for the three Steinhart-Hart equation constants. The range of values is -99.999 to +99.999 for all three constants. These values are scaled by the appropriate exponential value for the Steinhart-Hart equation.

POINTS OF INTEREST The LDC-3916370 Series Laser Diode Controller module uses these constants to convert the thermistor resistance measurement into a temperature.

EXAMPLES "Tec:CONST 1, 2.33, 0.5 " -action: sets C1 to 1.000, C2 to 2.330, and C3 to 0.500.

- Front Panel
- Remote

TEC:CONST?

The TEC:CONST? query returns the values of the selected channel's Steinhart-Hart constants.

SYNTAX DIAGRAM

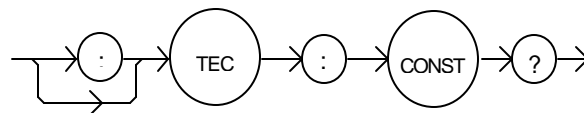

PARAMETERS None. The response data represent the values of C1, C2, and C3, respectively.

POINTS OF INTEREST These values are pre-scaled so that the exponential value is not given. The actual value of C1 is scaled by 10E-3, C2 by 10E-4, and C3 by 10E-7.

EXAMPLES "TEC:CONST?" -response: 1.111,2.03,0.85 means C1 = 1.111, C2 = 2.030, and C3 = 0.850.

- Front Panel
- Remote

TEC:CONV:R

The TEC:CONV:R command converts thermistor resistance ($K\Omega$) to temperature ($^{\circ}C$).

SYNTAX DIAGRAM

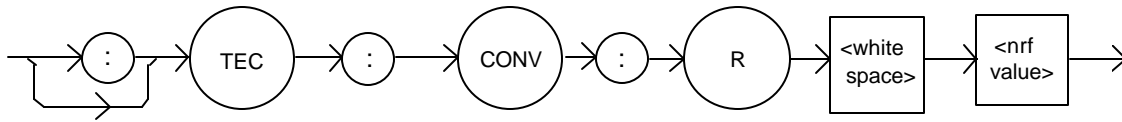

PARAMETERS An <nrf value> that corresponds to a resistance in $K\Omega$.

POINTS OF INTEREST The selected channel's Steinhart-Hart constants C1, C2 and C3 are used to convert resistance ($K\Omega$) to temperature ($^{\circ}C$).

EXAMPLES "TEC:CONV:R 12.456" 12.456 $K\Omega$ is converted to temperature and saved in memory.

- Front Panel
- Remote

TEC:CONV:R?

The TEC:CONV:R? query converts thermistor resistance ($K\Omega$) to temperature ($^{\circ}C$) and returns the value of the most recent conversion.

SYNTAX DIAGRAM

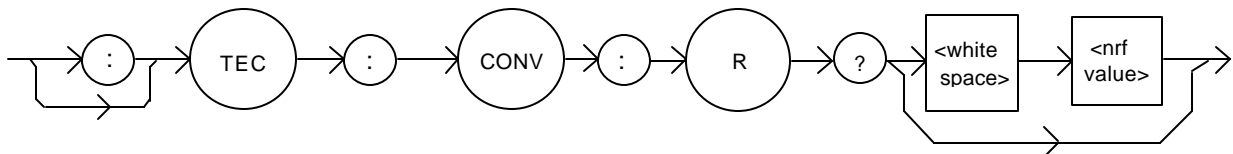

PARAMETERS Either no parameter or an <nrf value> that corresponds to a resistance in $K\Omega$.

POINTS OF INTEREST The calibration constants C1, C2 and C3 are used to convert resistance to temperature.

EXAMPLES "TEC:CONV:R?" Returns a value that corresponds to the temperature of the most recent conversion.

"TEC:CONV:R? 12.789" Converts 12.789 $K\Omega$ to temperature and returns a number that corresponds to temperature in $^{\circ}C$.

- Front Panel
- Remote

TEC:CONV:T

The TEC:CONV:T command converts temperature (°C) to thermistor resistance (KΩ).

SYNTAX DIAGRAM

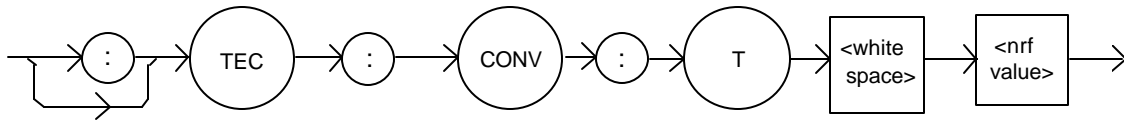

PARAMETERS An <nrf value> that corresponds to a temperature in °C.

POINTS OF INTEREST The selected channel's Steinhart-Hart constants C1, C2 and C3 are used to convert temperature (°C) to resistance (KΩ).

EXAMPLES "TEC:CONV:T 25.6" 25.6 °C is converted to resistance and saved in memory.

- Front Panel
- Remote

TEC:CONV:T?

The TEC:CONV:T? query converts temperature (°C) to thermistor resistance (KΩ) and returns the value of the most recent conversion.

SYNTAX DIAGRAM

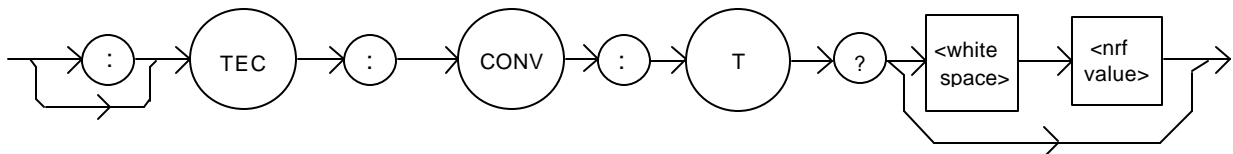

PARAMETERS Either no parameters or an <nrf value> that corresponds to a temperature in °C.

POINTS OF INTEREST The calibration constants C1, C2 and C3 are used to convert temperature to resistance.

EXAMPLES "TEC:CONV:T?" Returns a number that corresponds to the resistance value of the most recent conversion.

"TEC:CONV:T? 35.5" Converts 35.5 °C to resistance and returns a number that corresponds to resistance in KΩ.

The TEC:ENABle: command path is used to get to the selected channel's TEC status enable commands and queries.

The following commands may be reached directly from the TEC:ENABle: command path.

TEC:ENABle:COND
TEC:ENABle:COND?
TEC:ENABle:EVEnt
TEC:ENABle:EVEnt?
TEC:ENABle:OUTOFF
TEC:ENABle:OUTOFF?

- Front Panel
- Remote

TEC:ENABLE:COND

The TEC:ENABLE:COND command sets the selected channel's TEC Condition Status Enable register. The bits in this register determine which TEC conditions are summarized in the 3916 Status Byte.

SYNTAX DIAGRAM

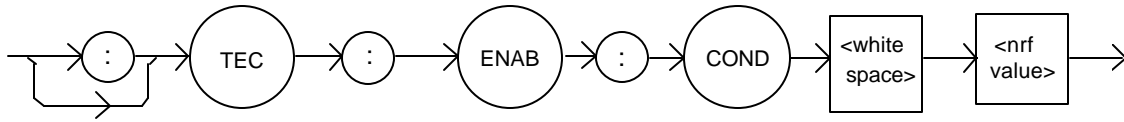

PARAMETERS An <nrf value> whose sum represents the enabled bits:

1 - TE Current Limit	256 - N/A
2 - TE Voltage Limit	512 - Output InTolerance
4 - N/A	1024 - Output On
8 - High Temperature Limit	2048 - N/A
16 - N/A	4096 - N/A
32 - N/A	8192 - N/A
64 - Sensor Open	16384 - N/A
128 - TE Module Open	32768 - N/A

POINTS OF INTEREST

The contents of this register determine which of the conditions in the TEC Condition Status register are reported to the 3916 Status Byte. See Chapter 3 of this manual for more information on status reporting.

The existing TEC conditions can be monitored using the TEC:COND? query.

EXAMPLES

"TEC:ENAB:COND 513" -action: sets the selected channel's TEC Condition Status Enable register so that only the Output Out of Tolerance and Current Limit conditions will be reported in the status byte register.

- Front Panel
- Remote

TEC:ENABLE:COND?

The TEC:ENABLE:COND? query returns the value of the selected channel's TEC Condition Status Enable register.

SYNTAX DIAGRAM

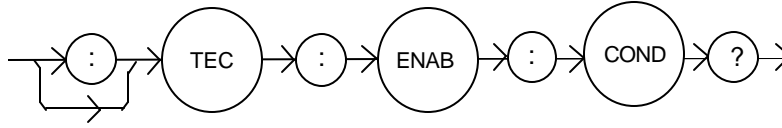

PARAMETERS None. The response is the sum of the following:

1 - TE Current Limit	256 - N/A
2 - TE Voltage Limit	512 - Output In Tolerance
4 - N/A	1024 - Output On
8 - High Temperature Limit	2048 - N/A
16 - N/A	4096 - N/A
32 - N/A	8192 - N/A
64 - Sensor Open	16384 - N/A
128 - TE Module Open	32768 - N/A

POINTS OF INTEREST

The enabled TEC conditions for the selected Channel can be set by using the TEC:ENABLE:COND command.

EXAMPLES

"TEC:ENAB:COND?" -response: 129, means that only the TE Module Open and TE Current Limit conditions for the selected channel will be reported in the 3916 status byte register.

The TEC:ENABle:EVEnt command sets the contents of the selected channel's TEC Event Status Enable register. The bits in this register determine which events are summarized in the 3916 Status Byte.

SYNTAX DIAGRAM

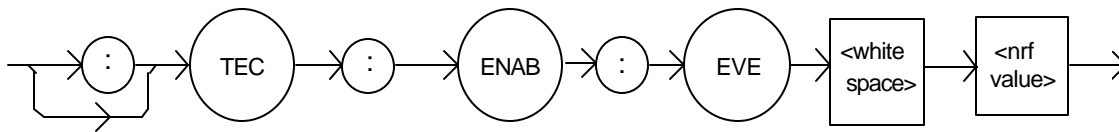

PARAMETERS An <nrf value> whose sum represents the enabled bits:

1 - TE Current Limit Changed State	256 - N/A
2 - TE Voltage Limit Changed State	512 - Output Changed Tolerance State
4 - N/A	1024 - Output On/Off Changed
8 - High Temperature Limit Changed State	2048 - N/A
16 - N/A	4096 - N/A
32 - N/A	8192 - N/A
64 - Sensor Open Changed State	16384 - N/A
128 - TE Module Open Changed State	32768 - N/A

POINTS OF INTEREST

Chapter 3 of this manual contains more information on status reporting.

The selected channel's TEC events can be monitored by the TEC:EVEnt? query.

EXAMPLES

"Tec:Enab:EVENT 1536" -action: the only events that will be reported to the 3916 status byte will be the Output On/Off Changed State and the Output Changed Tolerance State events.

- Front Panel
- Remote

TEC:ENABLE:EVEnt?

The TEC:ENABLE:EVEnt? query returns the value of the selected channel's TEC Event Status Enable register.

SYNTAX DIAGRAM

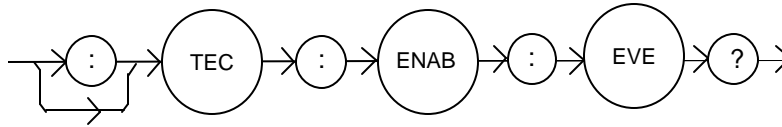

PARAMETERS None. The response is the sum of the following:

1 - TE Current Limit Changed State	256 - N/A
2 - TE Voltage Limit Changed State	512 - Output Changed Tolerance State
4 - N/A	1024 - Output On/Off Changed
8 - High Temperature Limit Changed State	2048 - N/A
16 - N/A	4096 - N/A
32 - N/A	8192 - N/A
64 - Sensor Open Changed State	16384 - N/A
128 - TE Module Open Changed State	32768 - N/A

POINTS OF INTEREST

The bits in this register determine which of the selected channel's events are summarized in the 3916 Status Byte; they can be set by using the TEC:ENABLE:EVEnt command.

The selected channel's TEC events can be monitored by the TEC:EVEnt? query.

EXAMPLES

"TEC:ENAB:EVE?" -response: 520, only the High Temperature Limit Changed State and Output Changed Tolerance State events will be reported to the 3916 status byte.

- Front Panel
- Remote

TEC:ENABle:OUTOFF

The TEC:ENABle:OUTOFF command sets the contents of the selected channel's TEC Output Off Enable register. The bits in this register determine which conditions will cause the TEC to automatically shut off.

SYNTAX DIAGRAM

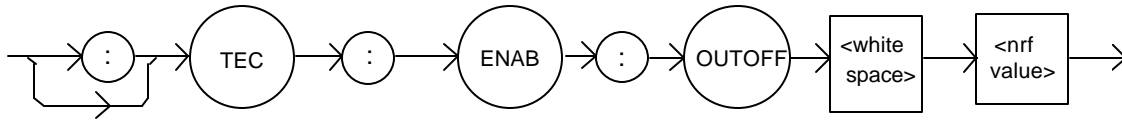

PARAMETERS An <nrf value> whose sum represents the enabled bits:

1 - TE Current Limit Condition	256 - Sensor Type Changed
2 - TE Voltage Limit Condition	512 - Output Out of Tolerance
4 - N/A	1024 - Sensor Shorted Condition
8 - High Temperature Limit Condition	2048 - N/A
16 - N/A	4096 - N/A
32 - N/A	8192 - N/A
64 - Sensor Open Condition	16384 - N/A
128 - Module Open Circuit Condition	32768 - N/A

POINTS OF INTEREST

The enabled TEC output-off bits can be read by using the TEC:ENABle:OUTOFF? query.

The default value for this register is 1480: the default conditions that will turn off the output are Temperature Limit, Sensor Open, Module Open Circuit, Sensor Change, and Sensor Shorted. The default value is placed in the register at power-up and as the result of a *RST command.

EXAMPLES

"TEC:ENABle:OUTOFF 72" -action: the only conditions that will cause the TEC to automatically turn off are Sensor Open and High Temperature Limit.

- Front Panel
- Remote

TEC:ENABLE:OUTOFF?

The TEC:ENABLE:OUTOFF? query returns the contents of the selected channel's TEC Output Off Enable register.

SYNTAX DIAGRAM

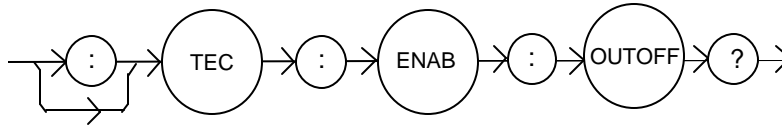

PARAMETERS None. The response is the sum of the following:

- | | |
|--------------------------------------|---------------------------------|
| 1 - TE Current Limit Condition | 256 - Sensor Type Changed |
| 2 - TE Voltage Limit Condition | 512 - Output Out of Tolerance |
| 4 - N/A | 1024 - Sensor Shorted Condition |
| 8 - High Temperature Limit Condition | 2048 - N/A |
| 16 - N/A | 4096 - N/A |
| 32 - N/A | 8192 - N/A |
| 64 - Sensor Open Condition | 16384 - N/A |
| 128 - Module Open Circuit Condition | 32768 - N/A |

POINTS OF INTEREST Use the TEC:ENABLE:OUTOFF command to set the conditions or events that will cause the output to automatically shut off.

EXAMPLES "TEC:ENAB:OUTOFF?" -response: 258, means that a Sensor Type Change Condition or a Voltage Limit Condition will cause the TEC output to be turned off.

- Front Panel
- Remote

TEC:EVEnt?

The TEC:EVEnt? query returns the contents of the selected channel's TEC Event Status register. Changes that occur in the Condition Status Register are latched in this register.

SYNTAX DIAGRAM

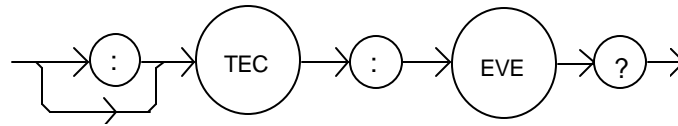

PARAMETERS None. The response is the sum of the following:

1 - TE Current Limit Changed State	256 - N/A
2 - TE Voltage Limit Changed State	512 - Output Changed Tolerance State
4 - N/A	1024 - Output On/Off Changed
8 - High Temperature Limit Changed State	2048 - N/A
16 - N/A	4096 - N/A
32 - N/A	8192 - N/A
64 - Sensor Open Changed State	16384 - N/A
128 - Module Open Circuit Changed State	32768 - N/A

POINTS OF INTEREST

The TEC Event Status register is only cleared after it is read using this command, or when a *CLS command is issued. This is a better method of ensuring that an event is captured by a controller than by monitoring the conditions using the TEC:COND? query.

You can specify which of these events are reported to the 3916 status byte by using the TEC:ENABLE:EVEnt command.

EXAMPLES

"TEC:EVE?" -response: 513, means that since the last TEC:EVEnt? query, the output went into or out of tolerance, and the TEC Current Limit condition has changed.

- Front Panel
- Remote

TEC:GAIN

The TEC:GAIN command sets the selected channel's TEC control loop proportional gain.

SYNTAX DIAGRAM

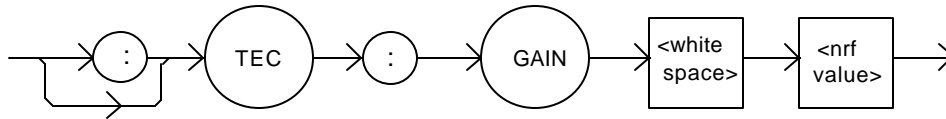

PARAMETERS An <nrf value> between 1 – 127.

POINTS OF INTEREST

A higher value may make the controller settle to the desired temperature setpoint quicker. A lower value may have less overshoot. The optimal value is highly dependent upon the user's system.

EXAMPLES "TEC:GAIN 100" -action: sets the TEC control loop gain to 100.

- Front Panel
- Remote

TEC:GAIN?

The TEC:GAIN? query returns the value of the selected channel's TEC control loop gain.

SYNTAX DIAGRAM

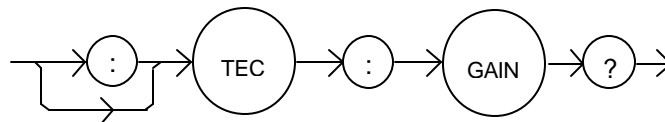

PARAMETERS None. The response is an integer value between 1 and 127.

POINTS OF INTEREST

The proportional gain is only used in constant-temperature or constant-resistance modes.

EXAMPLES "TEC:Gain?" -response: 30, the control loop gain has been set to 30.

- Front Panel
- Remote

TEC:ITE

The TEC:ITE command sets the selected channel's constant TEC current setpoint.

SYNTAX DIAGRAM

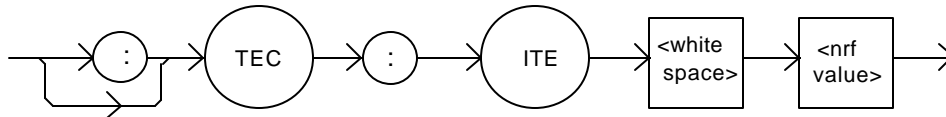

PARAMETERS An <nrf value> which represents the ITE setpoint current, in Amps.

POINTS OF INTEREST This set point is only used when the control mode is "ITE".

EXAMPLES "TEC:ITE 1" -action: sets the selected channel's TEC output current set point to 1.0 Amps.

"TEC:MODE:ITE; Tec:Ite 1.5; tec:out on" -action: selects constant-TEC current mode, sets the TEC output current setpoint to 1.5 A, and turns on the output. The output will drive a constant 1.5 A.

- Front Panel
- Remote

TEC:ITE?

The TEC:ITE? query returns the selected channel's measured TEC current.

SYNTAX DIAGRAM

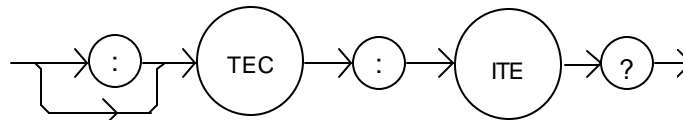

PARAMETERS None. The response value represents the measured ITE current, in Amps.

POINTS OF INTEREST The TEC load current is constantly measured and updated, regardless of the TEC control mode.
This measurement is updated approximately once every 600 mSec.

EXAMPLES "TEC:ITE?" -response: 1.43, means the measured TEC current is 1.43 Amps.

"Tec:Ite?" -response: -1.27, means the measured TEC current is -1.27 Amps.

- Front Panel
 - Remote
-

TEC:LIMit:

The TEC:LIMit: command path is used to get to the selected Channel's TEC limit commands.

The following commands may be reached directly from the TEC:LIMit: command path.

```
TEC:LIMit:ITE  
TEC:LIMit:ITE?  
TEC:LIMit:THI  
TEC:LIMit:THI?
```

- Front Panel
- Remote

TEC:LIMit:ITE

The TEC:LIMit:ITE command sets the selected channel's TEC current limit.

SYNTAX DIAGRAM

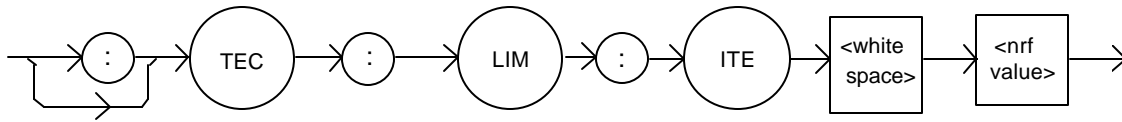

PARAMETERS An <nrf value> representing the limit value of the TE current, in Amps.

POINTS OF INTEREST Although the TEC:LIM:ITE value is positive, it limits both polarities of the TE current.

EXAMPLES "TEC:LIM:ITE 1.5" -action: the TEC current limit is set to 1.5 amps for the selected Channel.

- Front Panel
- Remote

TEC:LIMit:ITE?

The TEC:LIMit:ITE? query returns the value of the selected channel's TEC limit current.

SYNTAX DIAGRAM

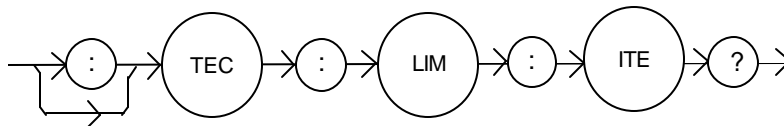

PARAMETERS None. The response is an <nrf value>.

POINTS OF INTEREST The response value is in amps.

EXAMPLES "TEC:LIM:ITE?" -response: 1.5, means the TEC output current limit is 1.5 amps for the selected Channel.

- Front Panel
- Remote

TEC:LIMit:THI

The TEC:LIMit:THI command sets the selected channel's TEC high temperature limit.

SYNTAX DIAGRAM

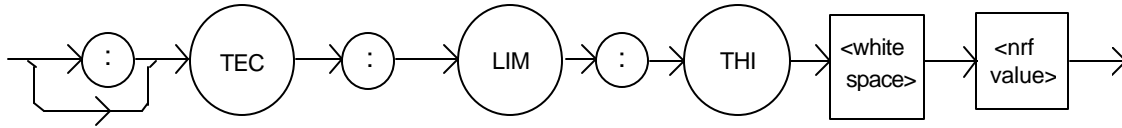

PARAMETERS An <nrf value> which represents the upper limit of the TEC load temperature, in °C.

POINTS OF INTEREST

By default, the TEC controller automatically shuts off if the measured temperature ever gets above this value. This behavior can be disabled using the TEC:ENABLE:OUTOFF command.

The THI limit value must be in the range 0 - 199.9 °C.

EXAMPLES "TEC:LIM:THI 100" -action: sets the selected channel's TEC load temperature limit to 100.0 °C.

- Front Panel
- Remote

TEC:LIMit:THI?

The TEC:LIMit:THI? query returns the value of the selected channel's TEC high temperature limit.

SYNTAX DIAGRAM

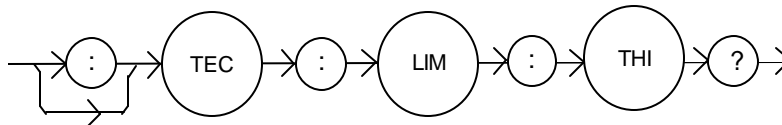

PARAMETERS None. The response is an <nrf value>.

POINTS OF INTEREST

If the high temperature limit is set too low, the TEC output may not be able to be turned on, if the high temperature condition is enabled to turn the TEC output off (see TEC:ENABLE:OUTOFF).

EXAMPLES "TEC:LIM:Thi?" -response: 30.5, the TEC high temperature limit is 30.5 °C.

- Front Panel
- Remote

TEC:MODE?

The TEC:MODE? query returns the selected channel's present TEC control mode.

SYNTAX DIAGRAM

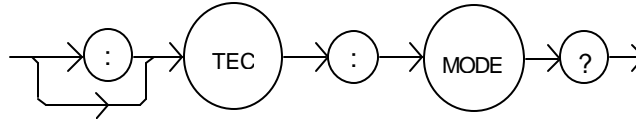

PARAMETERS None. The response is a character response.

POINTS OF INTEREST The TEC output is controlled so that the chosen quantity (temperature, thermistor resistance, or TEC current) is kept constant.

EXAMPLES "Tec:MODE?" -response: ITE; constant ITE (current) mode is in effect.

 ":TEC:Mode?" -response: R; constant R (thermistor resistance) mode is in effect.

 "Tec:Mode?" -response: T, constant T (temperature, as measured by the thermistor) mode is in effect.

- Front Panel
- Remote

TEC:MODE:

The TEC:MODE: command path is used to get to the selected Channel's TEC mode selection commands.

The following commands may be reached directly from the TEC:MODE: command path.

TEC:MODE:ITE
 TEC:MODE:R
 TEC:MODE:T

- Front Panel
- Remote

TEC:MODE:ITE

The TEC:MODE:ITE command selects constant TE current mode for the selected channel's TEC controller.

SYNTAX DIAGRAM

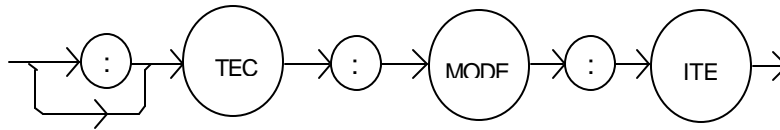

PARAMETERS None.

POINTS OF INTEREST This mode keeps the TEC current constant, regardless of load temperature variations.

Changing modes causes the output to be forced off.

EXAMPLES "TEC:MODE:ITE" -action: sets the TEC controller for constant TEC current operation.

- Front Panel
- Remote

TEC:MODE:R

The TEC:MODE:R command selects constant thermistor resistance mode for the selected channel's TEC controller.

SYNTAX DIAGRAM

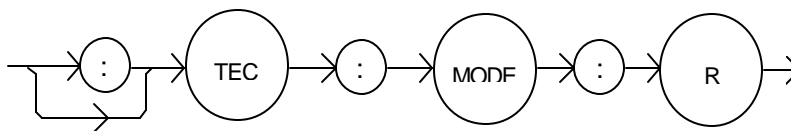

PARAMETERS None.

POINTS OF INTEREST Since sensor resistance is a function of temperature, this mode also controls the TEC output load temperature, but it bypasses the use of the conversion constants for set point calculation. This allows finer control of temperature in cases where the sensor's temperature model (and therefore the constants) is not known.

Changing modes causes the selected TEC's output to be forced off.

EXAMPLES "TEC:MODE:R" -action: sets the TEC controller for constant thermistor resistance control mode.

- Front Panel
- Remote

TEC:MODE:T

The TEC:MODE:T command selects constant temperature mode for the selected channel's TEC controller.

SYNTAX DIAGRAM

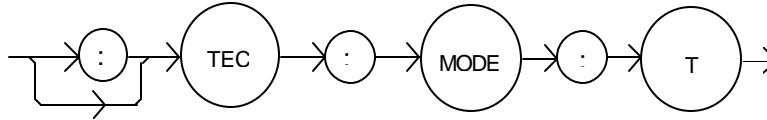

PARAMETERS None.

POINTS OF INTEREST Since TEC load temperature is derived from sensor resistance, constant R and T modes are related. In T mode the set point is converted to resistance using the appropriate constants (see TEC:CONSTant command) and thermistor type (see TEC:SENsor command).

EXAMPLES "TEC:MODE:T" -action: sets the TEC controller for constant temperature control mode.

- Front Panel
- Remote

TEC:OUTput

The TEC:OUTput command turns the selected channel's TEC output on or off.

SYNTAX DIAGRAM

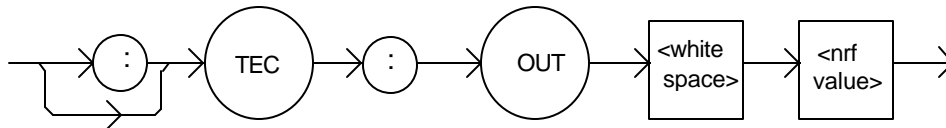

PARAMETERS An <nrf value>; 1 = on, 0 = off.

POINTS OF INTEREST After the selected TEC output is turned on, it may be useful to wait until the output is stable (within tolerance) before performing further operations on the selected channel, but it is not necessary.

EXAMPLES "TEC:OUTPUT 1" -action: turns the TEC output on.

"Tec:Out 0" -action: turns the TEC output off.

"Tec:Out OFF" -action: turns the TEC output off.

- Front Panel
- Remote

TEC:OUTput?

The TEC:OUTput? query returns the selected channel's TEC controller OUTPUT switch status.

SYNTAX DIAGRAM

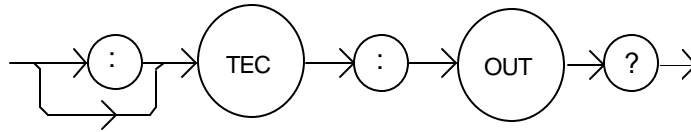

PARAMETERS None. The response is an <nrf value>.

POINTS OF INTEREST Although the status of the switch is on, the selected TEC output may not have reached the set point value.

EXAMPLES "Tec:Out?" -response: 0, means the TEC output is off.
 "TEC:OUT?" -response: 1, means the TEC output is on.

- Front Panel
- Remote

TEC:R

The TEC:R command sets the selected channel's constant-resistance setpoint.

SYNTAX DIAGRAM

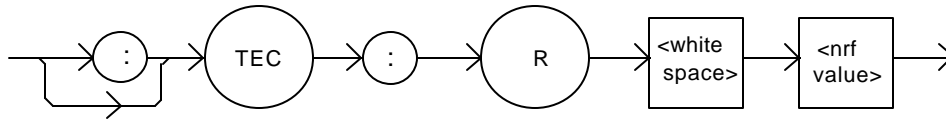

PARAMETERS An <nrf value> which represents the thermistor set point value, in Ohms.

POINTS OF INTEREST The R set point is used to control the TEC output in R mode only.

The range for the R setpoint parameter is 0.001 to 500.0 k Ω .

EXAMPLES "TEC:R 20.5" -action: sets the setpoint thermistor to 20.5 k Ω .

"TEC:Mode:R; TEC:R 10" -action: sets the set point thermistor to 10.0 k Ω . The module controls the output current to maintain a constant thermistor resistance of 10.0 k Ω , if the output is on.

- Front Panel
- Remote

TEC:R?

The TEC:R? query returns the selected channel's measured thermistor resistance.

SYNTAX DIAGRAM

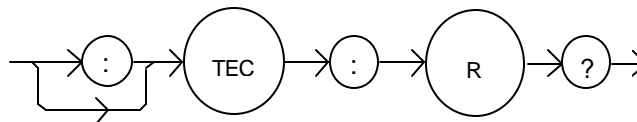

PARAMETERS None. The response value is the measured thermistor resistance, in k Ω .

POINTS OF INTEREST Measured temperature is derived from the thermistor resistance measurement.

This measurement is updated approximately once every 600 mSec.

EXAMPLES "TEC:R?" -response: 10.543, means the measured thermistor resistance is 10.543 k Ω .

"Tec:R?" -response: 0.128, means the measured resistance is 128 Ω .

- Front Panel
- Remote

TEC:SEnSor

The TEC:SEnSor command sets the selected channel's thermistor sense current.

SYNTAX DIAGRAM

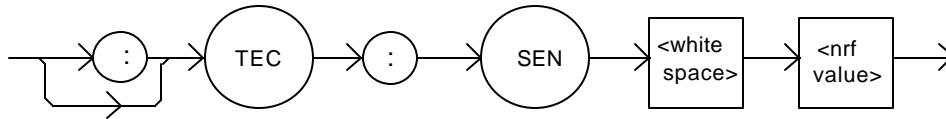

PARAMETERS An <nrf value> which represents the thermistor sense current. 1 = 100 μ A, 2 = 10 μ A.

POINTS OF INTEREST

The thermistor sense current effects the measurement range of the thermistor. Since the 3916370 Series Laser Diode Controller has a useful measurement range of 5 volts, having two separate sense current ranges allows for a greater range of resistance measurement.

When the sense current is 10 μ A, the maximum resistance range is about 500 k Ω . When the sense current is 100 μ A, the maximum is about 50 k Ω . The optimum sense current setting depends on the expected thermistor resistance for the temperature set point.

EXAMPLES "TEC:Sen 1" -action: sets the thermistor sense current to 100 μ A.

- Front Panel
- Remote

TEC:SEnSor?

The TEC:SEnSor? query is used to read back the selected channel's thermistor sense current setting. This value is a coded representation of the thermistor sense current.

SYNTAX DIAGRAM

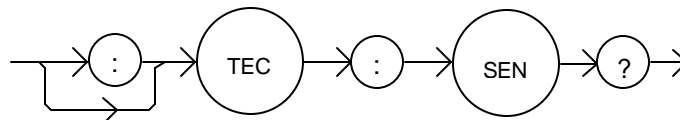

PARAMETERS None. The response value of 1 = 100 μ A; 2 = 10 μ A.

POINTS OF INTEREST

The sense current used affects the optimal measurement range of the thermistor. The internal measurement is actually a voltage in the range of 0 to 5.0 volts, approximately. The two sense current ranges allow two measurement ranges for the thermistor. The 10 μ A range may be more appropriate for lower temperatures, or for thermistors that have a higher resistance.

EXAMPLES "TEC:Sensor?" -response: 1, the thermistor sense current setting is 100 μ A.

- Front Panel
- Remote

TEC:SET:

The TEC:SET: command path is used to get to the selected channel's TEC set point queries.

The following commands may be reached directly from the TEC:SET: command path.

```
TEC:SET:ITE?
TEC:SET:R?
TEC:SET:T?
```

- Front Panel
- Remote

TEC:SET:ITE?

The TEC:SET:ITE? query returns the selected channel's constant TE current (ITE) set point value.

SYNTAX DIAGRAM

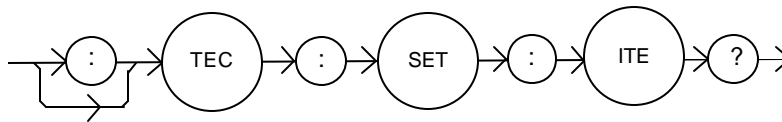

PARAMETERS None. The response represents the ITE set point for the selected Channel, in Amps.

POINTS OF INTEREST The TEC output is controlled to this set point value only when constant ITE mode is in effect.

EXAMPLES "TEC:SET:ITE?" -response: 1.0; the ITE set point is 1.0 Amps.

"Tec:Set:Ite?" -response: -0.5; the ITE set point is -0.5 Amps.

- Front Panel
- Remote

TEC:SET:R?

The TEC:SET:R? query returns the selected channel's constant thermistor resistance set point value.

SYNTAX DIAGRAM

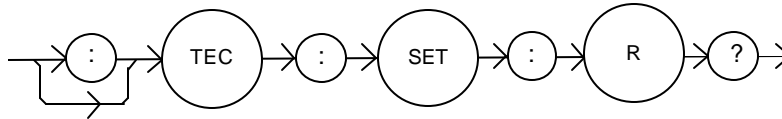

PARAMETERS None. The response represents the set point thermistor resistance value, in k Ω .

POINTS OF INTEREST The TEC output is controlled to this set point value only when constant R mode is in effect.

EXAMPLES "TEC:SET:R?" -response: 3.4, means the Constant Resistance set point is 3.4 k Ω .

"Tec:Set:R?" -response: 14.0, means the R set point is 14.0 k Ω .

- Front Panel
- Remote

TEC:SET:T?

The TEC:SET:T? query returns the selected channel's constant temperature set point value.

SYNTAX DIAGRAM

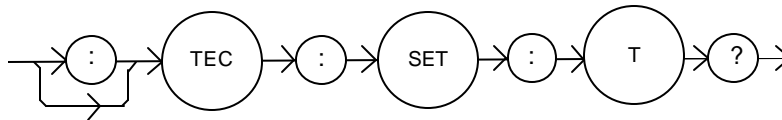

PARAMETERS None. The response represents the set point temperature, in $^{\circ}\text{C}$.

POINTS OF INTEREST The TEC output is controlled to this set point value only when constant T mode is in effect.

EXAMPLES "TEC:SET:T?" -response: 33.4, means the Constant Temperature set point is 33.4 $^{\circ}\text{C}$.

"Tec:Set:t?" -response: -4.0, means the constant T set point is -4.0 $^{\circ}\text{C}$.

The TEC:SYNCI? query returns the selected channel's measured TE current, in Amps.

SYNTAX DIAGRAM

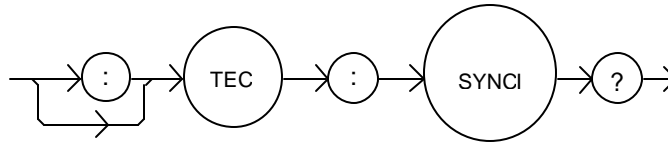

PARAMETERS None. The response is an <nrf value> representing current in Amps.

POINTS OF INTEREST

This is a “synchronized” measurement: the TEC measurement system is connected to the current-measure signal when this query is received. A current measurement is made, and the result is returned as the response. After the measurement is made, the measurement system returns to its normal function, switching between the various signals and measuring them.

The response time to this query is from 200 msec to 250 msec, but the measurement is made as soon as the query is received. In contrast, the tec:ite? query returns immediately, but the measurement can be up to 600 msec old.

EXAMPLES "TEC:SYNCI?" -response: 1.3, means the measured TE current is 1.3 A.

- Front Panel
- Remote

TEC:SYNCR?

The TEC:SYNCR? query returns the selected channel's measured thermistor resistance in k Ω .

SYNTAX DIAGRAM

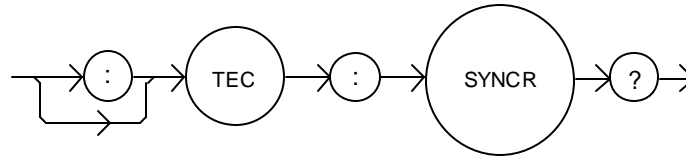

PARAMETERS None. The response value is an <nrf value> representing resistance in k Ω .

POINTS OF INTEREST

This is a “synchronized” measurement: the TEC measurement system is connected to the thermistor resistance-measure signal when this query is received. A resistance measurement is made, and the result is returned as the response. After the measurement is made, the measurement system returns to its normal function, switching between the various signals and measuring them.

The response time to this query is from 200 msec to 250 msec, but the measurement is made as soon as the query is received. In contrast, the tec:r? query returns immediately, but the measurement can be up to 600 msec old.

EXAMPLES "TEC:SYNCR?" -response: 10.543, means the measured thermistor resistance is 10.543 k Ω .

- Front Panel
- Remote

TEC:SYNCT?

The TEC:SYNCT? query returns the selected channel's measured thermistor temperature in °C.

SYNTAX DIAGRAM

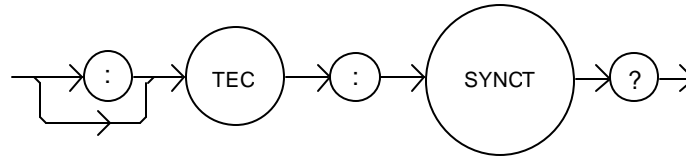

PARAMETERS None. The response value is an <nrf value> representing temperature in °C.

POINTS OF INTEREST Temperature is derived from the thermistor resistance measurement.

This is a “synchronized” measurement: the TEC measurement system is connected to the thermistor resistance-measure signal when this query is received. A resistance measurement is made, the temperature is calculated, and the result is returned as the response. After the measurement is made, the measurement system returns to its normal function, switching between the various signals and measuring them.

The response time to this query is from 200 msec to 250 msec, but the measurement is made as soon as the query is received. In contrast, the tec:t? query returns immediately, but the measurement can be up to 600 msec old.

EXAMPLES "TEC:SYNCT?" -response: 17.9, means the measured thermistor temperature is 17.9 °C.

- Front Panel
- Remote

TEC:SYNCV?

The TEC:SYNCV? query returns the selected channel's measured TE forward voltage, in Volts.

SYNTAX DIAGRAM

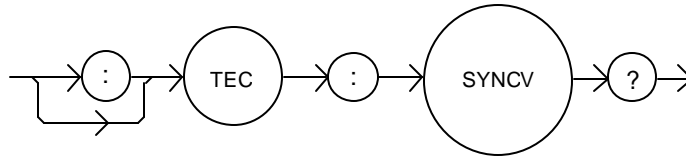

PARAMETERS None. The response value is an <nrf value> representing voltage in Volts.

POINTS OF INTEREST

This is a “synchronized” measurement: the TEC measurement system is connected to the voltage-measure signal when this query is received. A voltage measurement is made and the result is returned as the response. After the measurement is made, the measurement system returns to its normal function, switching between the various signals and measuring them.

The response time to this query is from 200 msec to 250 msec, but the measurement is made as soon as the query is received. In contrast, the tec:v? query returns immediately, but the measurement can be up to 600 msec old.

EXAMPLES "TEC:SYNCV?" -response: 1.9, means the measured forward voltage is 1.9 V.

- Front Panel
- Remote

TEC:T

The TEC:T command sets the selected channel's constant temperature set point value.

SYNTAX DIAGRAM

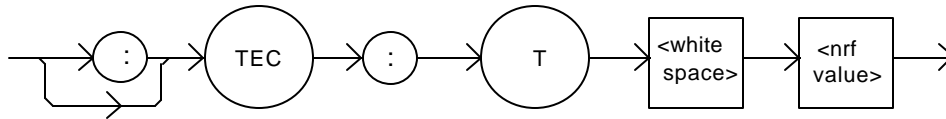

PARAMETERS An <nrf value> which represents the constant temperature setpoint value, in °C.

POINTS OF INTEREST The temperature will be controlled to this set point only when the TEC is operated in T mode.

The valid range for temperature setpoints is -99.9 °C to 199.9 °C.

EXAMPLES "Tec:T 20" -action: sets the selected TEC's temperature set point to 20.0°C.

"TEC:MODE:T; TEC:T 25.3" -action: selects constant-temperature control mode, sets the temperature set point to 25.3 °C. The output is controlled to this value, if the output is on.

- Front Panel
- Remote

TEC:T?

The TEC:T? query returns the selected channel's temperature measurement value.

SYNTAX DIAGRAM

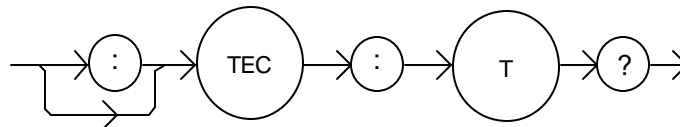

PARAMETERS None. The response is an <nrf value>.

POINTS OF INTEREST The measured temperature is valid for all modes of TEC operation. Temperature is continually updated, approximately once every 600 mSec.

The temperature is calculated from the thermistor resistance using the Steinhart-Hart constants entered using the TEC:CONST command.

EXAMPLES "TEC:T?" -response: 10.42, means the measured temperature is 10.42°C.

The TEC:TOLerance command sets the selected channel's TE control tolerance parameters. These parameters consist of a window and a duration. When the controlled load's control variable is within the specified window about the setpoint for the specified duration, the load is said to be "in tolerance".

SYNTAX DIAGRAM

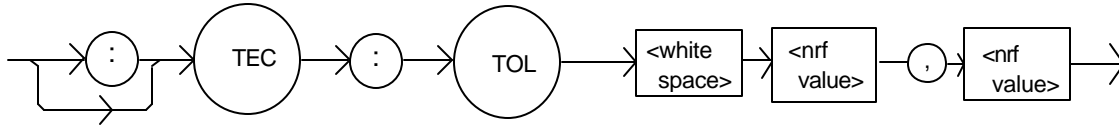

PARAMETERS Two <nrf values>; the first represents the window, in °C, kΩ, or Amps, depending on the TE control mode, with a range of 0.1 to 10.0. The second parameter represents the duration, in seconds, with a range of 0.001 to 50.0 seconds.

POINTS OF INTEREST You can determine when the load goes into tolerance by using the TEC:COND? query. Alternatively, you can check for operation complete. The OPC flag will be set after the TEC is turned on, when the load is finally in tolerance.

For example, assume the control mode is constant temperature, the set point is 10°C, and the tolerance parameters are 0.2 °C and 5 seconds. After the TEC output is turned on, the load's temperature will be "out of tolerance" until it is between 9.8 °C and 10.2 °C for 5 seconds, at which point the In Tolerance bit in the TEC Condition Status register will be set, and the OPC flag will be set.

If the mode is constant thermistor resistance (R), the first parameter is a resistance window in kΩ. There are not separate tolerance values for each mode.

The LDC-3916370 Series Laser Diode Controller defaults to a tolerance of 0.2 °C for 5 seconds, unless changed by the TEC:TOLerance command.

WARNING: If the tolerance is set too tight, the output may never reach tolerance.

EXAMPLES "TEC:T 44;TEC:Tol 0.5,10;tec:out on" -action: the controlled load will be in tolerance when the temperature is within 0.5 °C of 44 °C for a period of 10.0 seconds.

- Front Panel
- Remote

TEC:TOLerance?

The TEC:TOLerance? query returns the selected channel's TE control tolerance parameters.

SYNTAX DIAGRAM

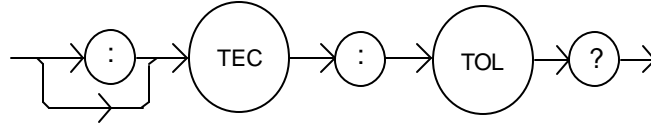

PARAMETERS None. The response consists of two data units, the first represents the tolerance window, in °C, kΩ, or Amps (depending on the mode). The second represents the tolerance duration, in seconds.

POINTS OF INTEREST The TEC tolerance specification is also used in the TEC status event and condition registers, so entering or exiting TEC temperature tolerance may be tested by polling via the TEC:COND? query. It may also be used to generate service requests.

EXAMPLES "Tec:Tol?" -response: "0.2,5", means the selected Channel has a TEC tolerance window of 0.2 °C or 0.2 kΩ or 0.2A (depending on the mode) with a duration of 5.0 seconds.

"TEC:TOL?" -response: "1.0,20", means the selected Channel has a TEC tolerance window of 1.0 °C or 1.0 kΩ, or 1.0 A (depending on the mode) with a duration of 20.0 seconds.

- Front Panel
- Remote

TEC:V?

The TEC:V? query returns the selected channel's voltage measurement value.

SYNTAX DIAGRAM

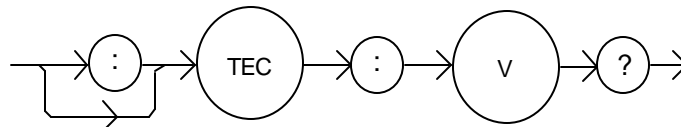

PARAMETERS None. The response is an <nrf value>, the units are Volts.

POINTS OF INTEREST The voltage measurement is updated approximately every 600 msec.

EXAMPLES "TEC:V?" -response: 1.3, means the TEC voltage is 1.3 Volts.

CHAPTER 5	1
CALIBRATION AND TROUBLESHOOTING GUIDE	1
INTRODUCTION	1
CALIBRATION OVERVIEW	1
Recommended Equipment	1
LOCAL CALIBRATION OF THE TEMPERATURE CONTROLLER	3
Thermistor Calibration	3
ITE Current Calibration	4
TE Voltage Calibration	5
LOCAL CALIBRATION OF THE LASER CURRENT SOURCE	6
Current Source Calibration	6
IPD Current Calibration	7
Laser Forward Voltage Measurement Calibration	7
REMOTE CALIBRATION OF THE 3916370 CONTROLLER	8
Thermistor Calibration	8
ITE Current Calibration	10
TE Voltage Calibration	12
Laser Current Source Calibration	13
LDI Calibration	13
IPD Current Calibration	14
Laser Forward Voltage Measurement Calibration	15
TROUBLESHOOTING GUIDE	17

CHAPTER 5

CALIBRATION AND TROUBLESHOOTING GUIDE

INTRODUCTION

This chapter describes calibration of your 3916370 Series Laser Diode Controller Module. Descriptions of the required test instruments, calibration conditions, and the detailed procedures for calibration of the instrument's Temperature Controller and the Laser Diode Current Source are included. A troubleshooting guide is also offered for some of the more common failure symptoms. This chapter is divided into three major sections: Local (front panel) calibration, remote (through the GPIB Interface) calibration, and a troubleshooting guide.

CALIBRATION OVERVIEW

There are several calibrations to be performed for a completely calibrated 3916370 Laser Diode Controller. The Temperature Controller calibration consists of calibrating the temperature sensors, the TE bipolar current source, and the TE load voltage measurement. The Laser Diode Current Source calibration consists of calibrating the current source, the photodiode monitor feedback ammeter, and the forward voltage measurement. The current limits are calibrated internally by the instrument, using measurements supplied by the user, as part of the calibration process.

Your 3916370 Series Controller Module can be calibrated while installed in a 3916 mainframe with the case closed. It should be calibrated every 12 months or whenever performance verification indicates that calibration is necessary, such as differences between set point and measurement display values which exceed the accuracy specification. Calibrate the instrument under laboratory conditions. We recommend calibration at $23^{\circ}\text{C} \pm 1.0^{\circ}\text{C}$. When necessary, however, the 3916370 Series Laser Diode Controller may be calibrated at its intended use temperature if this is within the specified operating temperature range of 0 to 40°C .

The 3916370 Series Laser Diode Controller module should be allowed to warm up for at least 1 hour before calibration.

Recommended Equipment

Recommended test equipment for calibrating the 3916370 Series Laser Diode Controller module is listed in Table 5.1. Equipment other than that shown in the table may be used if the specifications meet or exceed those listed.

<u>Description</u>	<u>Mfg./Model</u>	<u>Specification</u>
DMM	HP 3457A	DC Amps (@ 1.0 A): $\pm 0.02\%$ Resistance (@ $10\ \Omega$): 0.02% 0.1 μA or 0.1 mV resolution

Table 5.1 Recommended Test Equipment

It will be necessary to connect various loads and circuits to the outputs of the module for the calibration procedure. The devices required for most of the calibration loads are listed in Table 5.2. A schematic is shown in Figure 5.1 for the photodiode calibration circuit, with the required components listed in Table 5.3.

<u>TEMPERATURE CONTROLLER CALIBRATION</u>	
Temperature Sensor (Thermistor) Calibration	
10 μ A setting	50 k Ω resistor, 1% 1/4W
	400 k Ω resistor, 1% 1/4W
100 μ A setting	4 k Ω resistor, 1% 1/4W
	40 k Ω resistor, 1% 1/4W
Current Source Calibration	1 Ω 20W resistor, low TCR
Voltage Measurement Calibration	2 Ω 20W resistor, low TCR
<u>LASER CURRENT SOURCE CALIBRATION</u>	
Current Source Calibration	1 Ω 20W resistor, low TCR
Voltage Measurement Calibration	15 Ω 20W resistor, low TCR
<u>PHOTODIODE MONITOR CALIBRATION (See schematic in Fig. 5.1)</u>	

Table 5.2 Required Calibration Components

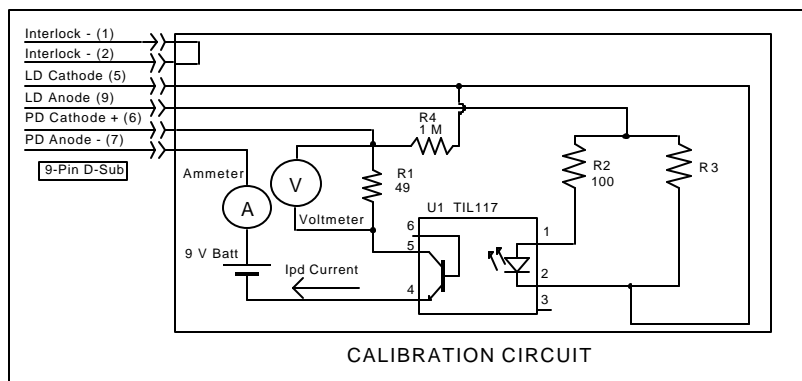

Figure 5.1 I_{PD} Calibration Circuit

<u>COMPONENTS FOR PHOTODIODE CURRENT (I_{PD}) CALIBRATION CIRCUIT</u>	
R1	49 Ω resistor, 1% 1/4W
R2	100 Ω resistor, 1%, 1/4W
R4	1.0 M Ω resistor, 1% 1/4W
R3	5 Ω resistor, 1%, 10W
U1	TIL 117 opto isolator
Battery	9V Battery
Connector	9-pin D-Sub, Male

Table 5.3 Components for I_{pd} Calibration Circuit

LOCAL CALIBRATION OF THE TEMPERATURE CONTROLLER

Thermistor Calibration

The following procedure is for calibrating the 100 μA and 10 μA thermistor current sources so that the thermistor resistance measurement for these ranges will meet the stated accuracy specifications.

- a. Install the module into a 3916 mainframe. Turn on the mainframe and allow it to warm up for at least one hour.
- b. Using the multimeter, measure and record the exact resistance of your metal film resistors. You should know the exact resistance of the resistors to at least 1 Ω .

NOTE

For best accuracy in your calibration, a four-point probe resistance measurement is recommended. After connecting the probe to the calibration resistor, wait at least a half a second before recording the resistance value. Heat from your fingers can change the value of the resistance.

-
- c. Enter the 10 μA sensor calibration mode by pushing the **(DISPLAY) MAIN** front panel button, then the **Sys. Config** soft key, then the **Cal.** soft key, then the **Cal TEC** soft key, then the **Therm10 Cal** soft key. The module's 10 μA calibration screen will appear.
 - d. Press the **Start** soft key. The internal calibration procedure will begin, and the screen will prompt you to connect a 50 k Ω resistor.
 - e. Connect a resistor of approximately 50 k Ω (you should know the exact resistance value to at least 1 Ω) to the TE connector's sensor pins (pins 7 and 8). Allow the measurement to settle for at least 10 seconds.
 - f. Enter the exact resistance value in k Ω into the "RReal" adjust field, and press Enter. Be sure not to enter more than 7 characters, including the decimal point. The screen will now prompt you to attach a 400 k Ω resistor.
 - g. Connect a resistor of approximately 400 k Ω (again you should know the exact value to within 1 Ω), and allow the measurement to settle for at least 30 seconds.
 - h. Enter the exact resistance value into the "RReal" adjust field, and press Enter. The internal calibration procedure will make its calculations, and when it has finished it will indicate so on the screen.

Follow a similar procedure for the 100 μA sensor calibration, except use the **Therm100 Cal** soft key, and use a 4 k Ω and a 40 k Ω resistor.

ITE Current Calibration

The following procedure is for calibrating the TE current source. The internal calibration procedure sets the current to two negative values and two positive values. You must enter the exact current that you measure at each of these points. The internal procedure will then use this information to calibrate the current source setpoint, measurement, and limit circuits.

- a. With the output off, connect a 1 Ω , 20 W resistor across the TEC output terminals (TE Module (+), pins 1 & 2; and TE Module (-), pins 3 & 4). Positive current flows from the module (+) pins to the module (-) pins.
- b. Connect a calibrated DMM across the load resistor. You will be calculating TE current (ITE) in the following manner using Ohm's Law:

$$I = E / R$$

where E is the accurately measured voltage across the resistor, and R is the accurately measured load resistance. I is the calculated current in Amps. A 4-point probe resistance measurement is recommended.

NOTE

We recommended that the load resistor be temperature-controlled during the calibration.

The current may be measured directly using an ammeter with a range of at least 2 A, and accurate to within ± 0.01 A. Connect the ammeter in series with a load resistor of value no more than 1 W.

- c. Enter the ITE calibration mode by pushing the **(DISPLAY) MAIN** front panel button, then the **Sys. Config** soft key, then the **Cal.** soft key, then the **Cal TEC** soft key, then the **ITE Cal** soft key. The module's ITE calibration screen will appear.
- d. Press the **Start** soft key. The internal calibration procedure will turn on the output and drive the TE current to approximately 75% of its negative output range. Allow the current to settle for at least 10 seconds.
- e. Calculate or measure the actual current to within 0.01 A and enter the value (in Amps) into the "IReal" adjust area, press **(ADJUST) ENTER**. Be sure to include the minus sign, and do not enter more than five characters, including the minus sign and decimal point. If you do enter more than five characters, and as a result the minus sign is chopped off the left side of the display, press the **(ADJUST) CLEAR** button and re-enter the value. Otherwise the internal calibration procedure will either abort, or produce an incorrect calibration.

Repeat this process for the next three values of current that the internal procedure sets. The next three current settings are approximately 25% of negative output range, then 25% of positive output range, and finally 75% of positive output range. Allow the current to settle for at least 10 seconds at each step.

After you have entered the last actual current, the internal calibration procedure will perform the calibration for the current setpoint, measurement, and limit circuits. The screen will then display a message indicating that the calibration has finished.

TE Voltage Calibration

The following procedure is for calibrating the TE voltage measurement. The internal calibration procedure sets the current to a negative value and a positive value. You must enter the exact voltage that you measure at both of these points. The internal procedure will then use this information to calibrate the voltage measurement circuit.

- a. With the output off, connect a 2 Ω , 20 W resistor across the TEC output terminals (TE Module (+), pins 1 & 2; and TE Module (-), pins 3 & 4).
- b. Connect a calibrated voltmeter across the load resistor.
- c. Enter the TE voltage calibration mode by pushing the **(DISPLAY) MAIN** front panel button, then the **Sys. Config** soft key, then the **Cal.** soft key, then the **Cal TEC** soft key, then the **TE Volts Cal** soft key. The module's TE Volts calibration screen will appear.
- d. Press the **Start** soft key. The internal calibration procedure will turn on the output and drive the TE current to approximately 75% of its negative output range. Allow the current to settle for at least 10 seconds.
- e. Measure the voltage across the load resistor to within 0.01 V and enter the value in Volts into the "VReal" adjust area. Press **(ADJUST) ENTER**. Be sure to include the minus sign, and do not enter more than five characters, including the minus sign and decimal point. If you do enter more than five characters, and as a result the minus sign is chopped off the left side of the display, press the **(ADJUST) CLEAR** button and re-enter the value. Otherwise the internal calibration procedure will either abort, or produce an incorrect calibration.

After you have entered the first voltage, the internal cal procedure will set the output current to approximately 75% of positive output range. Measure the voltage across the load resistor, enter this measurement in the "VReal" adjust area, and press **(ADJUST) ENTER**. The internal cal procedure will calibrate the TE voltage measurement circuit, and the screen will display a "Completed" message.

LOCAL CALIBRATION OF THE LASER CURRENT SOURCE

There are three calibration adjustments for the LASER current source of the 3916370 Series Laser Diode Controller Module. They are: calibration of the constant current (LDI) source, calibration of the constant light power (I_{PD}) feedback circuit, and calibration of the laser forward voltage (LDV) measurement.

Current Source Calibration

The following procedure is for calibrating the laser current source. The internal calibration procedure sets the current to two values. You must enter the exact Laser Diode current that you measure at both of these points. The internal procedure will then use this information to calibrate the current source.

- a. With the output off, connect a 1 Ω, 20 W resistor across the LASER output terminals (Laser Anode, pin 9, and Laser Cathode, pin 5). Current will flow from the anode to the cathode.
- b. Connect a calibrated DMM across the load resistor. You will be calculating laser current (LDI) in the following manner using Ohm's Law:

$$I = E / R$$

where E is the accurately measured voltage across the resistor, and R is the accurately measured load resistance (a 4-point probe resistance measurement is recommended). I is the calculated current in Amps.

NOTE

We recommend that the load resistor be temperature-controlled during the calibration.

Alternatively, the current may be measured directly using an ammeter with a range of at least 2 A, and accurate to ± 0.001 mA. If you use the ammeter approach, you should connect the ammeter in series with a load resistor with a nominal value of 1 W.

-
- c. Enter the LDI calibration mode by pushing the **(DISPLAY) MAIN** front panel button, then the **Sys. Config** soft key, then the **Cal.** soft key, then the **Cal LAS** soft key, then the **LDI Cal** soft key. The module's LDI calibration screen will appear.
 - d. Press the **Start** soft key. The internal calibration procedure will turn on the output and drive the LD current to approximately 25% of full range. Allow the current to settle for at least 10 seconds.
 - e. Calculate or measure the actual current through the load resistor, enter that value (in mA) into the highlighted "IReal" adjust field on the screen, and press **(ADJUST) ENTER**. Do not enter more than eight characters, including the decimal point.
 - f. The internal cal procedure will then set the LD current to approximately 75% of full range. Allow the current to settle for at least 10 seconds.
 - g. Measure the actual current, and enter that value into the **IREAL** adjust field.

After you have entered the second value, the internal cal procedure calibrates the LD current measurement circuit, the LD current source for both low and high bandwidths, and the LD current limit circuit.

IPD Current Calibration

The following procedure is for calibrating the LASER I_{PD} (photodiode monitor) measurement circuit. The internal calibration procedure sets the current to two values. You must enter the resulting I_{PD} (photodiode monitor) current that you measure at both of these points. The internal procedure will then use this information to calibrate the I_{PD} measurement circuit.

- a. With the output off, connect the IPD calibration circuit, Figure 5.1, to the laser connector.
- b. Connect an ammeter with at least 5000 μA range and at least $\pm 0.1 \mu\text{A}$ accuracy as shown in the figure. This ammeter is in series with the Photodiode Anode input to the module, and directly measures the photodiode current.
- c. Enter the I_{PD} calibration mode by pushing the **(DISPLAY) MAIN** front panel button, then the **Sys. Config** soft key, then the **Cal.** soft key, then the **Cal LAS** soft key, then the **IPD Cal** soft key. The module's IPD calibration screen will appear.
- d. Press the **Start** soft key. The internal calibration procedure will turn on the output and drive the laser current until the PD current is approximately 15% of full range. Allow the current to settle for at least 10 seconds.
- e. Use the ammeter and measure the actual photodiode current, enter that value (in μA) into the highlighted "IPDReal" adjust field on the screen, and press **(ADJUST) ENTER**. Do not enter more than seven characters, including the decimal point.
- f. The internal calibration procedure will then drive the laser current until the PD current is approximately 65% of full range. Allow the current to settle for at least 10 seconds.
- g. Measure the actual photodiode current, enter that value (in μA) into the highlighted "IPDReal" adjust field on the screen, and press **(ADJUST) ENTER**.

After you have entered the second value, the internal cal procedure calibrates the I_{PD} current measurement circuit and displays a "Completed" message on the screen.

Laser Forward Voltage Measurement Calibration

The following procedure is for calibrating the LASER forward voltage (LDV) measurement circuit. The internal calibration procedure sets the current to two values. You must enter the resulting forward voltage that you measure at both of these points. The internal procedure will then use this information to calibrate the LDV measurement circuit.

- a. With the output off, connect a 15Ω 20W load resistor across the Laser Anode sense/drive terminals (pins 8 and 9) and Laser Cathode sense/drive terminals (pins 4 and 5).
- b. Connect a voltmeter with at least 10V range and accuracy of at least $\pm 0.01\text{V}$ across the load resistor.
- c. Enter the LDV calibration mode by pushing the **(DISPLAY) MAIN** front panel button, then the **Sys. Config** soft key, then the **Cal.** soft key, then the **Cal LAS** soft key, then the **LDV Cal** soft key. The module's LDV calibration screen will appear.
- d. Press the **START** soft key. The internal calibration procedure will turn on the output and drive the LD current to approximately 4% of full range. Allow the current to settle for at least 10 seconds.
- e. Then measure the voltage across the load resistor, enter that value (in Volts) into the highlighted "VReal" adjust field on the screen, and press **(ADJUST) ENTER**. Do not enter more than seven characters, including the decimal point.

- f. The internal calibration procedure will then drive the LD current to approximately 18% of full range. Allow the current to settle for at least 10 seconds.
- g. Measure the actual voltage across the load resistor, enter that value (in Volts) into the highlighted “VReal” adjust field on the screen, and press **(ADJUST) ENTER**.

After you have entered the second value, the internal cal procedure calibrates the laser forward voltage measurement circuit and displays a “Completed” message on the screen.

This ends the section on front panel (local) calibration of your controller. The next section discusses calibration through the IEEE488.2 GPIB interface.

REMOTE CALIBRATION OF THE 3916370 CONTROLLER

The 3916370 Controller Modules can be calibrated remotely via the GPIB Interface. All of the required calibration commands are listed in Table 4.1 in Chapter 4. The procedures below are general guidelines for writing a program to calibrate your instrument.

Thermistor Calibration

The following procedure is for remotely calibrating the 100 μA and 10 μA thermistor current sources so that the thermistor resistance measurements for these ranges will meet the stated accuracy specifications.

- a. Install the module into a 3916 mainframe. Turn on the mainframe and allow it to warm up for at least one hour.
- b. Using the multimeter, measure and record the exact resistance of your metal film resistors. You should know the exact resistance of the resistors to at least 1 Ω .

NOTE

For best accuracy in your calibration, a four-point probe resistance measurement is recommended. After connecting the probe to the calibration resistor, wait at least a half a second before recording the resistance value. Heat from your fingers can change the value of the resistance.

-
- c. Connect a resistor of approximately 50 $\text{k}\Omega$ to the TEC connector’s sensor pins (pins 7 and 8).
 - d. Enter the 10 μA sensor calibration mode by sending the following command over GPIB:
TEC:CAL:SEN 2.

This starts the internal 10 μA sensor calibration procedure. Allow the measurement to settle for at least 10 seconds.

If this calibration value is to be measured and entered remotely via a GPIB controlled DMM, for example, the actual value of the resistance should not be entered until the LDC-3916 controller is ready to receive it.

- e. Check to see if the internal cal procedure is ready for a measurement, send the following query to the module:

TEC:CAL:STATUS?

The cal procedure is ready for a measurement if it returns the value “1”. Query the status until the value that is returned is “1”.

- f. Enter the exact resistance value (that you previously measured) in k Ω of the first resistor by sending the following command:

TEC:CAL:MEAS (*value in kW*) e.g. TEC:CAL:MEAS 45.678

NOTE

The internal cal procedure will store this value and briefly change its measurement status to “0” to indicate that it is not yet ready for another measurement.

- g. Connect the 400 k Ω resistor and allow the measurement to settle for at least 10 seconds.

- h. Check to see if the internal cal procedure is ready for a measurement, send the following query to the module:

TEC:CAL:STATUS?

The cal procedure is ready for a measurement if it returns the value “1”. Query the status until the value that is returned is “1”.

When the status query returns “1”, enter the value of the second resistor:

- i. Enter the exact resistance value (that you previously measured) in k Ω of the second resistor by sending the following command:

TEC:CAL:MEAS (*value in kW*) e.g. TEC:CAL:MEAS 398.877

The internal cal procedure will now complete the calibration of the 10 μ A sensor measurement circuit. It indicates that it is finished by responding to the status query with the value “2”.

Follow a similar procedure for the 100 μ A sensor calibration, except use the following command to start the cal:

TEC:CAL:SEN 1.

For the 100 μ A sensor calibration, use 4 k Ω for the first resistor and 40 k Ω for the second.

ITE Current Calibration

The following procedure is for remotely calibrating the TE current source. The internal calibration procedure sets the current to two negative values and two positive values. You must measure the current at each of these points and send the measurements to the module over GPIB. The internal procedure will then use this information to calibrate the current source setpoint, measurement, and limit circuits.

- a. With the output off, connect a 1 Ω , 20 W resistor across the TEC output terminals (TE Module (+), pins 1 & 2, and TE Module (-), pins 3 & 4).
- b. Connect a calibrated DMM across the load resistor. You will be calculating TE current (ITE) in the following manner using Ohm's Law:

$$I = E / R$$

where E is the accurately measured voltage across the resistor, and R is the accurately measured load resistance. I is the calculated current in Amps. A 4-point probe resistance measurement is recommended.

NOTE

We recommended that the load resistor be temperature-controlled during the calibration.

The current may be measured directly using an ammeter with a range of at least 2 A and accurate to within ± 0.01 A. If you use the ammeter approach, you should connect the ammeter in series with a load resistor with a nominal value of 1 W.

- c. Enter the ITE calibration mode by sending the following command over GPIB:

TEC:CAL:ITE

The internal cal procedure will begin by setting the TE output current to approximately 75% of its negative full range. Allow the current to settle for at least 10 seconds.

If this calibration value is to be measured and entered remotely via a GPIB controlled DMM, for example, the actual value of the current should not be entered until the LDC-3916 controller is ready to receive it.

- d. Check to see if the internal cal procedure is ready for a measurement by sending the following query to the module:

TEC:CAL:STATUS?

The cal procedure is ready for a measurement if it returns the value "1". Query the status until the value that is returned is "1".

- e. Enter the measured current in Amps by sending the following command:

TEC:CAL:MEAS (*current in Amps*) e.g. TEC:CAL:MEAS -1.45

NOTE

The internal cal procedure will store this value and briefly change its measurement status to “0” to indicate that it is not yet ready for another measurement. This will occur after each time a new measurement is entered.

- f. The controller will set the output current to approximately 25% of its negative output range. Allow the current to settle for at least 10 seconds.
- g. Check to see if the internal cal procedure is ready for the second measurement. Send the following query to the module:

TEC:CAL:STATUS?

The cal procedure is ready for a measurement if it returns the value “1”. Query the status until the value that is returned is “1”.

- h. Enter the second actual measured TE current:

TEC:CAL:MEAS (*current in Amps*) e.g. TEC:CAL:MEAS -0.43

- i. The controller will set the output current to approximately 25% of its positive output range. Allow the current to settle for at least 10 seconds.
- j. Check to see if the internal cal procedure is ready for the third measurement. Send the following query to the module:

TEC:CAL:STATUS?

The cal procedure is ready for a measurement if it returns the value “1”. Query the status until the value that is returned is “1”.

- k. Enter the third actual measured TE current:

TEC:CAL:MEAS (*current in Amps*) e.g. TEC:CAL:MEAS 0.45

- l. The controller will set the output current to approximately 75% of its positive output range. Allow the current to settle for at least 10 seconds.
- m. Check to see if the internal cal procedure is ready for the fourth measurement. Send the following query to the module:

TEC:CAL:STATUS?

The cal procedure is ready for a measurement if it returns the value “1”. Query the status until the value that is returned is “1”.

- n. Enter the fourth actual measured TE current:

TEC:CAL:MEAS (*current in Amps*) e.g. TEC:CAL:MEAS 1.47

After you have entered the last measured current, the internal calibration procedure will perform the calibration for the current setpoint, measurement, and limit circuits. The cal procedure will set the status to the value “2” to indicate that it has finished.

TE Voltage Calibration

The following procedure is for remotely calibrating the TE voltage measurement circuit. The internal calibration procedure sets the current to two values. You must measure the voltage at each of these points and send the measurements to the module over GPIB. The internal procedure will then use this information to calibrate the TE voltage measurement circuit.

- a. With the output off, connect a 2 Ω , 20 W load resistor across the TEC output terminals (TE Module (+), pins 1 & 2; and TE Module (-), pins 3 & 4).
- b. Connect a calibrated voltmeter across the load resistor.
- c. Enter the TE voltage calibration mode by sending the following command over GPIB:

TEC:CAL:V

The internal cal procedure will begin by setting the TE output current to approximately 75% of its negative full range. Allow the current to settle for at least 10 seconds. If this calibration value is to be measured and entered remotely via a GPIB controlled DMM, for example, the actual value of the resistance should not be entered until the LDC-3916 controller is ready to receive it.

- d. Check to see if the internal cal procedure is ready for the measurement. Send the following query to the module:

TEC:CAL:STATUS?

The cal procedure is ready for a measurement if it returns the value "1". Query the status until the value that is returned is "1".

- e. Enter the actual measured TE voltage:

TEC:CAL:MEAS (*voltage in Volts*) e.g. TEC:CAL:MEAS -2.91

NOTE

The internal cal procedure will store this value and briefly change its measurement status to "0" to indicate that it is not yet ready for another measurement. This will occur after each time a new measurement is entered.

- f. The controller will set the output current to approximately 75% of its positive output range. Allow the current to settle for at least 10 seconds.
- g. Check to see if the internal cal procedure is ready for the measurement. Send the query to the module:

TEC:CAL:STATUS?

The cal procedure is ready for a measurement if it returns the value "1". Query the status until the value that is returned is "1".

- h. Enter the actual measured TE voltage:

TEC:CAL:MEAS (*voltage in Volts*) e.g. TEC:CAL:MEAS 2.94

After you have entered the second measured voltage, the internal calibration procedure will perform the calibration for the voltage measurement circuit. The cal procedure will then set the status to the value "2" to indicate that it has finished.

Laser Current Source Calibration

There are three calibration adjustments for the Laser current source of the 3916370 Series Laser Diode Controller Module. They are: calibration of the constant current (LDI) source, calibration of the laser forward voltage (LDV) measurement, and calibration of the constant light power (I_{pD}) feedback circuit.

LDI Calibration

The following procedure is for remotely calibrating the laser current source. The module's internal calibration procedure sets the current to two values. You must measure and enter the exact Laser Diode current at both of these points. The module's internal cal procedure will then use this information to calibrate the current source.

- a. With the output off, connect a 1 Ω , 20 W resistor across the LASER output terminals (Laser Anode, pin 9, and Laser Cathode, pin 5).
- b. Connect a calibrated DMM across the load resistor. You will be calculating laser current (LDI) in the following manner using Ohm's Law:

$$I = E / R$$

where E is the accurately measured voltage across the resistor, and R is the accurately measured load resistance (a 4-point probe resistance measurement is recommended). I is the calculated current in Amps.

NOTE

We recommend that the load resistor be temperature-controlled during the calibration.

Alternatively, the current may be measured directly using an ammeter with a range of at least 2 A, and accurate to ± 0.001 mA. If you use the ammeter approach, you should connect the ammeter in series with a load resistor with a nominal value of 1 W.

- c. Enter the Laser Current Source calibration mode by sending the following command over GPIB:
LAS:CAL:LDI
- d. The internal cal procedure will begin by setting the Laser output current to approximately 25% of its full range. Allow the current to settle for at least 10 seconds.

If this calibration value is to be measured and entered remotely via a GPIB controlled DMM, for example, the actual value of the current should not be entered until the LDC-3916 controller is ready to receive it.

- e. Check to see if the internal cal procedure is ready for the measurement. Send the following query to the module:
LAS:CAL:STATUS?

The cal procedure is ready for a measurement if it returns the value "1". Query the status until the value that is returned is "1".

- f. Enter the measured current in mA by sending the following command:
LAS:CAL:MEAS (*current in mA*) e.g. LAS:CAL:MEAS 267.878

NOTE

The internal cal procedure will store this value and briefly change its measurement status to “0” to indicate that it is not yet ready for another measurement. This will occur after each time a new measurement is entered.

- g. The controller will set the output current to approximately 75% of its output range. Allow the current to settle for at least 10 seconds.
- h. Check to see if the internal cal procedure is ready for the measurement. Send the following query to the module:

LAS:CAL:STATUS?

The cal procedure is ready for a measurement if it returns the value “1”. Query the status until the value that is returned is “1”.

- I. Enter the second measured current in mA by sending the following command:
LAS:CAL:MEAS (*current in mA*) e.g. LAS:CAL:MEAS 527.986

After you have entered the second measured current, the internal calibration procedure will perform the calibration for the laser current setpoint, current measurement, and current limit circuits. The cal procedure will then set the status to the value “2” to indicate that it has finished.

IPD Current Calibration

The following procedure is for remotely calibrating the LASER I_{PD} (photodiode monitor) measurement circuit. The module’s internal calibration procedure sets the current to two values. You must enter the resulting I_{PD} (photodiode monitor) current that you measure at both of these points. The module’s internal cal procedure will then use this information to calibrate the I_{PD} measurement circuit.

- a. With the output off, connect the IPD calibration circuit, Figure 5.1, to the laser connector.
- b. Connect an ammeter with at least 5000 μA range and at least $\pm 0.1 \mu\text{A}$ accuracy as shown in the figure. This ammeter is in series with the Photodiode Anode input to the module, and directly measures the photodiode current.
- c. Enter the Laser Current Source calibration mode by sending the following command over GPIB:
LAS:CAL:MDI

NOTE

“MDI” stands for “Monitor Diode Current”.

- d. The internal calibration procedure will turn on the output and drive the laser current until the PD current is approximately 15% of full range. Allow the current to settle for at least 10 seconds.

If this calibration value is to be measured and entered remotely via a GPIB controlled DMM, for example, the actual value of the current should not be entered until the LDC-3916 controller is ready to receive it.

- e. Check to see if the internal cal procedure is ready for the measurement. Send the following query to the module:

LAS:CAL:STATUS?

The cal procedure is ready for a measurement if it returns the value “1”. Query the status until the value that is returned is “1”.

- f. Enter the measured current in μA by sending the following command:

LAS:CAL:MEAS (*current in mA*) e.g. LAS:CAL:MEAS 745.321

NOTE

The internal cal procedure will store this value and briefly change its measurement status to “0” to indicate that it is not yet ready for another measurement. This will occur after each time a new measurement is entered.

- g. The controller will drive the laser current until the PD current to approximately 65% of full range. Allow the current to settle for at least 10 seconds.
- h. Check to see if the internal cal procedure is ready for the measurement. Send the following query to the module:

LAS:CAL:STATUS?

The cal procedure is ready for a measurement if it returns the value “1”. Query the status until the value that is returned is “1”.

- i. Enter the measured current in μA by sending the following command:

LAS:CAL:MEAS (*current in mA*) e.g. LAS:CAL:MEAS 3573.344

After you have entered the second measured photodiode current, the internal calibration procedure will perform the calibration for the photodiode current measurement circuit. The cal procedure will then set the status to the value “2” to indicate that it has finished.

Laser Forward Voltage Measurement Calibration

The following procedure is for remotely calibrating the laser forward voltage measurement circuit. The module’s internal calibration procedure sets the current to two values. You must measure and enter the forward voltage at both of these points. The module’s internal cal procedure will then use this information to calibrate the voltage measurement system.

- a. With the output off, connect a 15Ω 20W load resistor across the Laser Anode sense/drive terminals (pins 8 and 9) and Laser Cathode sense/drive terminals (pins 4 and 5).

- b. Connect a calibrated voltmeter across the load resistor (“plus” lead to Anode).
- c. Enter the Laser voltage measurement calibration mode by sending the following command over GPIB:
LAS:CAL:LDV
- d. The internal cal procedure will begin by setting the Laser output current to approximately 4% of its full range. Allow the current to settle for at least 10 seconds, or until the measured voltage is stable.

If this calibration value is to be measured and entered remotely via a GPIB controlled DMM, for example, the actual value of the current should not be entered until the LDC-3916 controller is ready to receive it.

- e. Check to see if the internal cal procedure is ready for the measurement. Send the following query to the module:
LAS:CAL:STATUS?

The cal procedure is ready for a measurement if it returns the value “1”. Query the status until the value that is returned is “1”.

- f. Enter the measured voltage in Volts by sending the following command:
LAS:CAL:MEAS (*voltage in Volts*) e.g. LAS:CAL:MEAS 0.59

NOTE

The internal cal procedure will store this value and briefly change its measurement status to “0” to indicate that it is not yet ready for another measurement. This will occur after each time a new measurement is entered.

- g. The controller will set the output current to approximately 18% of its output range. Allow the current to settle for at least 10 seconds.
- h. Check to see if the internal cal procedure is ready for the measurement. Send the following query to the module:
LAS:CAL:STATUS?

The cal procedure is ready for a measurement if it returns the value “1”. Query the status until the value that is returned is “1”.

- i. Enter the second measured voltage in Volts by sending the following command:
LAS:CAL:MEAS (*voltage in Volts*) e.g. LAS:CAL:MEAS 2.74

After you have entered the second measured voltage, the internal calibration procedure will perform the calibration for the laser forward voltage measurement circuit. The cal procedure will then set the status to the value “2” to indicate that it has finished.

This ends the calibration guide.

TROUBLESHOOTING GUIDE

This section is a guide to troubleshooting the 3916370 Series Controller Modules. Some of the more common symptoms are listed here, and the appropriate troubleshooting actions are given. We recommend that the user start at the beginning of this guide. Read the symptom descriptions, and follow the steps for the corrective actions which apply. If you encounter problems which are beyond the scope of this guide, contact your ILX Lightwave customer service representative.

SYMPTOM

CORRECTIVE ACTIONS

GENERAL

LDC-3916 Series unit will not power up

Check AC Power line voltage and power cord connection.

Power on, but outputs have been shut off.
Instrument may be “locked up” or instrument
Resets itself.

This may occur if the instrument loses power (AC line) briefly or line voltage drops below specification. If instrument is “locked up”, power it off and then on to restart.

LASER CONTROLLER

Power on, but no current output

Check Interlock pins on LASER input connector on instrument rear panel. These pins must be shorted either directly or through a switch. The front-panel Laser Enable switch should also be on.

If Open Circuit is indicated (E503), check the load connections and cable and then try again. Be sure the cable connector is securely fastened to the back of the module(s). Make sure that Anode Voltage Sense and Cathode Voltage Sense (pins 8 and 4) are connected to your laser.

Output current at limit, can't be lowered

If IPD or PPD mode is used, check the monitor diode (feedback) connections. Make sure that the polarity of the monitor photodiode is correct. Also check if the photodiode bias is off.

If in I_{LBW} or I_{HBW} mode, check the current set point and I LIMIT setting. Setting the output below the limit may require several turns of the adjust knob if the set point is much greater than the desired limit setting.

Output goes off intermittently

Check the interlock circuit. An intermittent interlock will turn the output off.

Check that the AC power cord connection is secure. Power-line drop-outs may reset the unit and when power is restored, the output will be off.

Unable to adjust output	<p>Make sure that the ISET adjust parameter is highlighted.</p> <p>Check the I LIMIT parameter; it should be set above 0 and above the laser operating current.</p> <p>Check the VLIMIT parameter, the voltage limit should be set above the operating voltage of your laser load.</p>
Power Mode operation has high output current, but little or no power is measured	Check the photodiode bias. If it is off, the circuit may act as an open feedback loop. Set the bias to on (-5V).
Output exceeds Power Limit	<p>It is possible via GPIB to disable turning off the output when the power limit is exceeded. Ensure that this is not the case. Default at power-up is to enable this safety feature.</p> <p>The “Power Limit” is not a hardware limit. It serves as a warning that the power measurement has exceeded the limit set point.</p>
Open Circuit Error occurs during calibration	Check load connections. Check that measuring meter does not auto-range (use non-auto-ranging modes).
Calibration is aborted unintentionally	Calibration modes will be aborted if an open circuit is detected or if entered measurements are invalid.
TEC CONTROLLER	
Power on, but no TE current output	Check the load connections and operating mode.
Power on, but temperature is not controlled	<p>If SENSOR OPEN indication, check the sensor connections.</p> <p>Check that the proper sensor current range is selected (either 10 μA or 100 μA).</p> <p>Check that C1 and C2 and C3 are correct values for your thermistor.</p> <p>Check that the GAIN setting is not too low and that the LIM I_{TE} value is not too low for your thermal load.</p>
Unable to adjust output or parameter	<p>Ensure that the desired parameter is highlighted.</p> <p>Check thermoelectric module current limit if in constant ITE mode, make sure it is higher than module rating.</p>

Output goes off intermittently

Check that the AC power cord connection is secure. Power-line drop-outs may reset the unit and when power is restored, the output will be off.

Check the TE module connections. A high impedance on the TE load may cause the output to exceed the compliance voltage momentarily. If enabled via GPIB, this condition will shut off the output.

Check the sensor connections at the module and the load.

Switching modes while the output is on will disable the output.